

NS Series

The HMI you can rely on



» Proven Reliability

» Best Match

» Machine Management

Machine Control at your fingertips

Expanding markets in emerging countries, short product cycles, and diversifying customer needs are just some of the factors that create drastic changes for the production industry.

To win in severe global market competition, you have to continue to grasp industry changes quickly, understand user needs accurately, and provide diverse forms of added value.

Omron will help you handle ever-changing customer needs with the three keywords of the NS Series.

Let your machines evolve

Best match

Omron has provided even greater compatibility with Omron PLCs and components to provide an advanced design process that lets you achieve appealing machines.

Machine management

The NS Series transforms machine HMIs from simple operation panels and turns them into machine management tools.

Proven reliability

The NS-series HMIs have a proven track record that will take your machines to a higher level of reliability.



NS Series

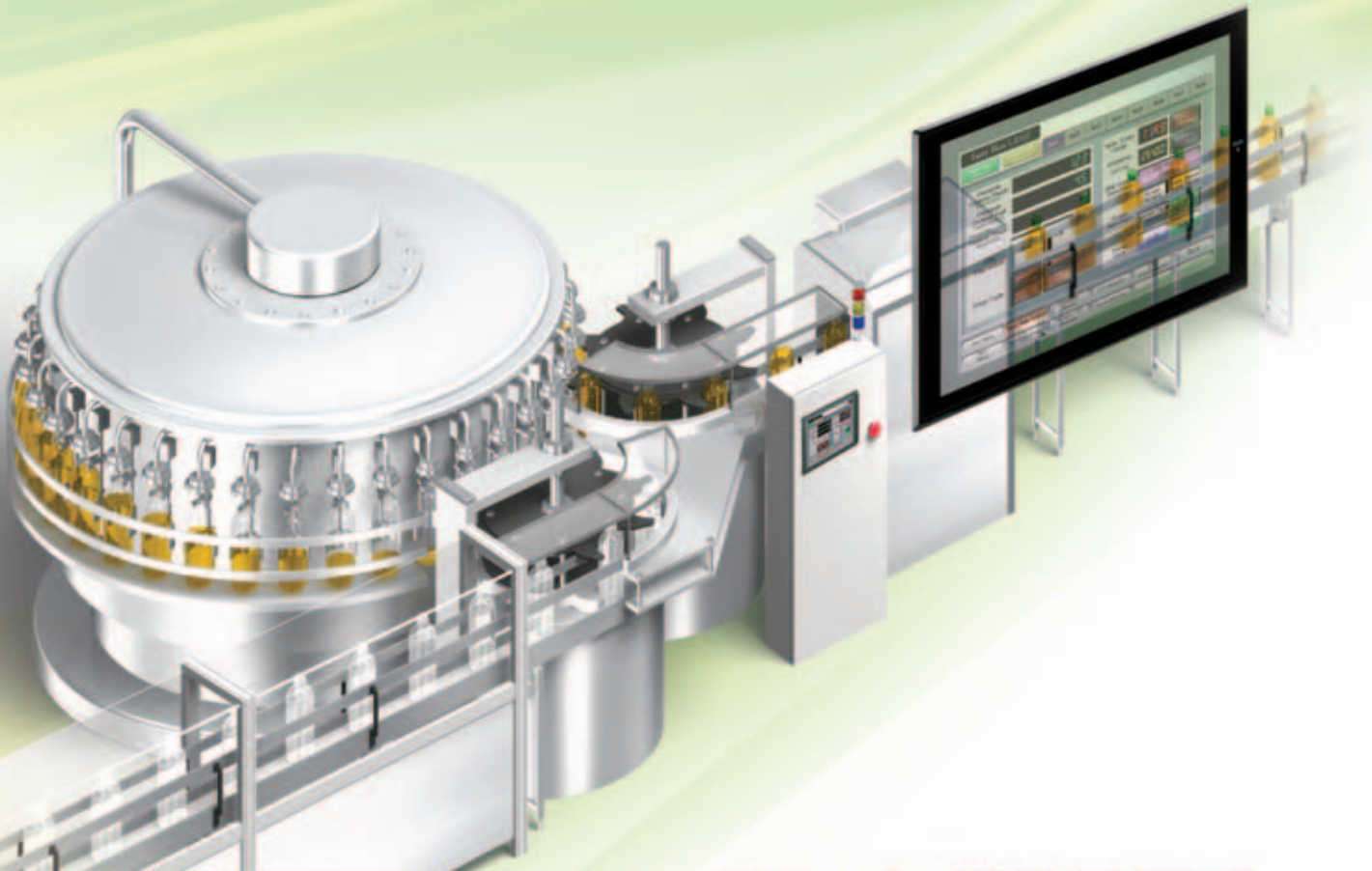

The best match possible

The amount of work and cost of connecting to Omron PLCs and components have been greatly reduced. The results is an incredible range of features that is possible only when unifying to one manufacturer. Connecting to the NJ-series Machine Automation Controller allows the machine designer to quickly achieve the features required by the user through support for improved troubleshooting and structured programming with structures and other new data types.

Machine management tool







The machine designer can easily implement PLC troubleshooting, machine troubleshooting, settings for servo drives, temperature controllers, and other control components, status monitoring of connected devices, and uploading/downloading of parameters.

Proven reliability

In the ten years since initial marketing, Omron has globally supplied numerous HMI solutions with the highly reliable NS Series at over 200 sales and service centers around the world.



NS Series Line-up

Standard Models

| 15 inches | Colour TFT | 12.1 inches | Colour TFT LED | | |
|---|-------------------------------|---|---------------------------|---|---------------------------|
|  | NS15-TX |  | NS12-TS | | |
| | 32,768 colours | | 32,768 colours | | |
| | XGA 1024 x 768 pixels | | SVGA 800 x 600 pixels | | |
| | Screen memory size: 60 MB | | Screen memory size: 60 MB | | |
| | USB Slave | | Controller Link | | |
| | Ethernet | | Video (RGB input only) | | |
| | USB Master | | RGB output | | |
| | RS-232C x 2 | | Ladder Monitor | | |
| RS-422A/485 | Memory Card | RS-232C x 2 | Memory Card | | |
| 10.4 inches | Colour TFT LED | 8.4 inches | Colour TFT LED | | |
|  | NS10-TV |  | NS8-TV | | |
| | 32,768 colours | | 32,768 colours | | |
| | VGA 640 x 480 pixels | | VGA 640 x 480 pixels | | |
| | Screen memory size: 60 MB | | Screen memory size: 60 MB | | |
| | USB Slave | | Controller Link | | |
| | Ethernet | | Video | | |
| | USB Master | | Ladder Monitor | | |
| | RS-232C x 2 | | Memory Card | RS-232C x 2 | Memory Card |
| 5.7 inches | Colour High-luminance TFT LED | 5.7 inches | Colour TFT LED | 5.7 inches | Monochrome STN |
|  | NS5-TQ |  | NS5-SQ |  | NS5 MQ |
| | 32,768 colours | | 32,768 colours | | 16 monochrome gradations |
| | QVGA 320 x 240 pixels | | QVGA 320 x 240 pixels | | QVGA 320 x 240 pixels |
| | Screen memory size: 60 MB | | Screen memory size: 60 MB | | Screen memory size: 60 MB |
| | USB Slave | | USB Slave | | USB Slave |
| | Ethernet | | Ethernet | | Ethernet |
| | RS-232C x 2 | | RS-232C x 2 | | RS-232C x 2 |
| | Memory Card | | Memory Card | | Memory Card |



NSH Series

Hand-held Models - A hand-held version of the NS5 is now available to perform operations at the production site.

| 5.7inches | Colour TFT LED | 5.7 inches | Colour TFT LED | Hand-held HMI Cable | |
|---|-----------------------|---|-----------------------|---|--|
|  | NSH5-SQR |  | NSH5-SQG |  | |
| | 32,768 colours | | 32,768 colours | | |
| | QVGA 320 x 240 pixels | | QVGA 320 x 240 pixels | | |
| | USB Slave | | USB Slave | | |
| | RS-232C/422A | | RS-232C/422A | | |
| Memory Card | Memory Card | RS-232C | RS-422A | | |
| Equipped with a red switch for an emergency stop input. | | Equipped with a gray switch for a stop input. | | | |
| Emergency stop (3 inputs) | | Emergency stop (3 inputs) | | | |

NSJ Series

Integrated Controller Models - HMI is unified with the Controller into one package to greatly help standardize equipment and reduce size.

| | | | | | |
|---|-------------------------|-----------------------------|-------------------------|-----------------------------|-----------------|
|  | 12.1inches | Colour TFT LED | 10.4 inches | Colour TFT LED | |
| | | NSJ12-TS01_-G5D | | NSJ10-TV01_-G5D | |
| | | 32,768 colours | | 32,768 colours | |
| | | SVGA 800 x 600 pixels | | VGA 640 x 480 pixels | |
| | | Screen memory size: 60 MB | | Screen memory size: 60 MB | |
| | | USB Slave | Controller Link | USB Slave | Controller Link |
| | | Ethernet | Ladder Monitor | Ethernet | Ladder Monitor |
| | | USB Master | Memory Card | USB Master | Memory Card |
| | | RS-232C x 3 | DeviceNet | RS-232C x 3 | DeviceNet |
| | | (Controller Section) | | (Controller Section) | |
| | I/O points: 1,280 | Program capacity: 60K steps | I/O points: 1,280 | Program capacity: 60K steps | |
| | Data Memory: 128K words | | Data Memory: 128K words | | |
|  | 8.4 inches | Colour TFT LED | 5.7 inches | Colour TFT LED | |
| | | NSJ8-TV01_-G5D | | NSJ5-TQ11_-G5D | |
| | | 32,768 colours | | 32,768 colours | |
| | | VGA 640 x 480 pixels | | QVGA 320 x 240 pixels | |
| | | Screen memory size: 60 MB | | Screen memory size: 60 MB | |
| | | USB Slave | Controller Link | USB Slave | Controller Link |
| | | Ethernet | Ladder Monitor | Ethernet | Memory Card |
| | | USB Master | Memory Card | RS-232C x 3 | DeviceNet |
| | | RS-232C x 3 | DeviceNet | | |
| | | (Controller Section) | | (Controller Section) | |
| | I/O points: 1,280 | Program capacity: 60K steps | I/O points: 1,280 | Program capacity: 60K steps | |
| | Data Memory: 128K words | | Data Memory: 128K words | | |

Software



CX-Designer

The software for project creation on the NS series, the CX-Designer Screen Design Software is so easy-to-use that anyone can master it. CX-Designer is included in CX-One and Sysmac Studio.



NS-Runtime

This software enables PLC communications to a personal computer by HMI created screens using CX-Designer.

The NS-series HMIs provide the highest possible compatibility with the road-proven CS/CJ-series the highest new NJ-series Controllers to achieve even greater added value in user machines.

The NJ-series Machine Automation Controllers

You can create a flexible, high-speed, high-precision system based on the NJ-series Machine Automation Controllers. Use tags to access any memory areas, or troubleshoot machines and systems by using the NS-series HMIs to make the most of the strengths of the NJ-series Controllers and to manage machines.



EtherNet/IP

NJ



EtherCAT



The CS/CJ-series PLCs for the reliability of a proven track record

Features are provided to easily connect to CS/CJ-series PLCs to take advantage of their proven track record. Many features that do not require screen creation or programming support everything from design through maintenance to take advantage of the compatibility of Omron PLCs and HMI and to serve as the face of your machines.

CS/CJ



Design

From conceptual designs through commissioning, operation, and maintenance, the NS Series supports every user need.

Reduced work



Troubleshooter

PAGE
10-11

NJ Troubleshooter

PLC Troubleshooter

Machine Troubleshooter



Best Match

PAGE
12-16

Smart Active Parts (SAP)

With EtherNet/IP

Direct Connection to temperature controllers



Multi-language Support

PAGE
16



Data logger & Recipe handling

PAGE
17



Screen Data Security Functions

PAGE
18

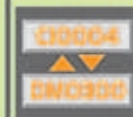

Device Data Transfer

PAGE
18



Multifunction Objects

PAGE
19



Versatile Graphs

PAGE
20



Good looking Screens and Objects

PAGE
21



CX-Designer Screen Design Software

PAGE
22-25

Start-up/operations

Attractive, convenient features for easier operation



Level:01
Level:02
Level:03
Level:04
Level:05



260,000-colour Video Display PAGE 26



Analog RGB Output PAGE 26



FTP Function and Web Interface PAGE 27

Level:01
Level:02
Level:03
Level:04
Level:05

User Security Functions PAGE 27

Features for reliability and complete maintenance



SPMA Single Port Multi Access PAGE 28

PLC Data Trace PAGE 29

Operating log PAGE 29

Ladder Monitor PAGE 30-31

Ordering and technical information PAGE 35-39

Troubleshooter

A Troubleshooter is provided for the connected Omron controller or PLC. This greatly reduces work requirements.

NJ Troubleshooter

Controller errors

Standard feature for NJ-series controllers

Errors are automatically detected and displayed on-screen along with corrective actions for the CPU unit, function modules, EtherCAT slaves, and CJ-series units that are connected in the NJ-series controller. Whenever an error might occur, you can recover normal operation quickly to reduce downtime without using user manuals, or support software on a computer.



User-defined errors

No Work Is Required to Create Alarm Screens.

Frames for alarm screens are provided as standard features in the NS-series HMIs. There is no need to create these screens separately. Management of the meanings of alarms is unified on the Controller, so you do not have to register, add, or correct addresses on the NS-series HMIs.

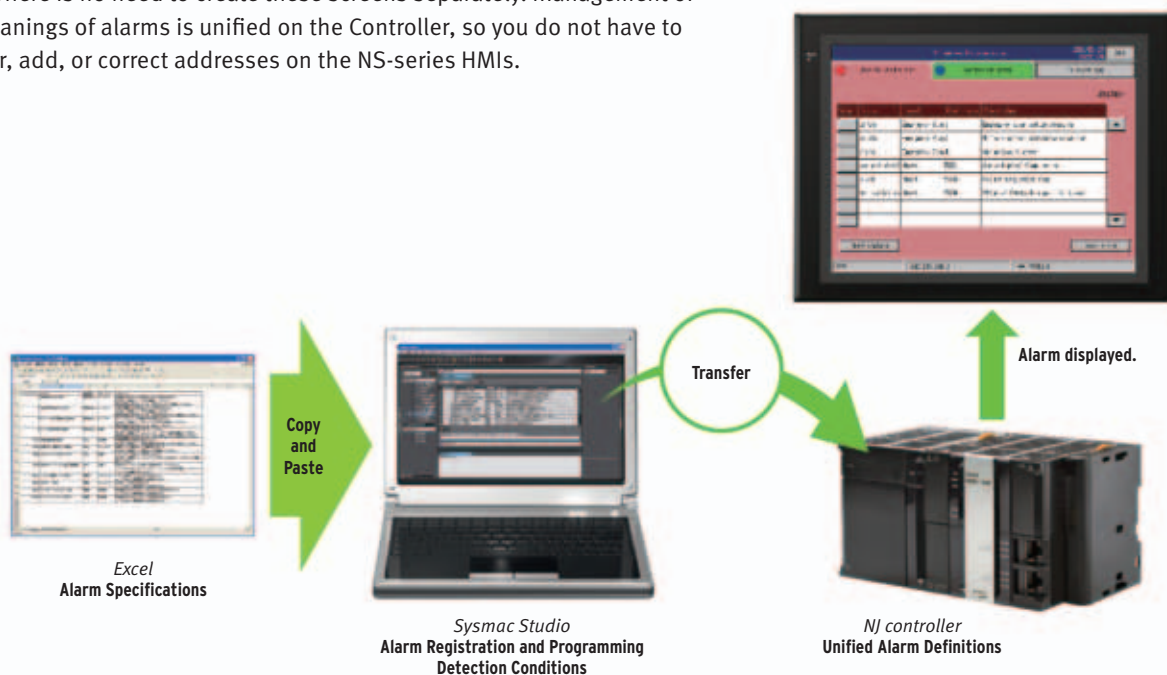

CS/CJ-series PLC Troubleshooter

Constantly monitors PLC errors

Automatically detects PLC errors and displays the error details and recovery procedure on the screen. Even if a problem occurs, it can be resolved quickly without referring to the manuals.

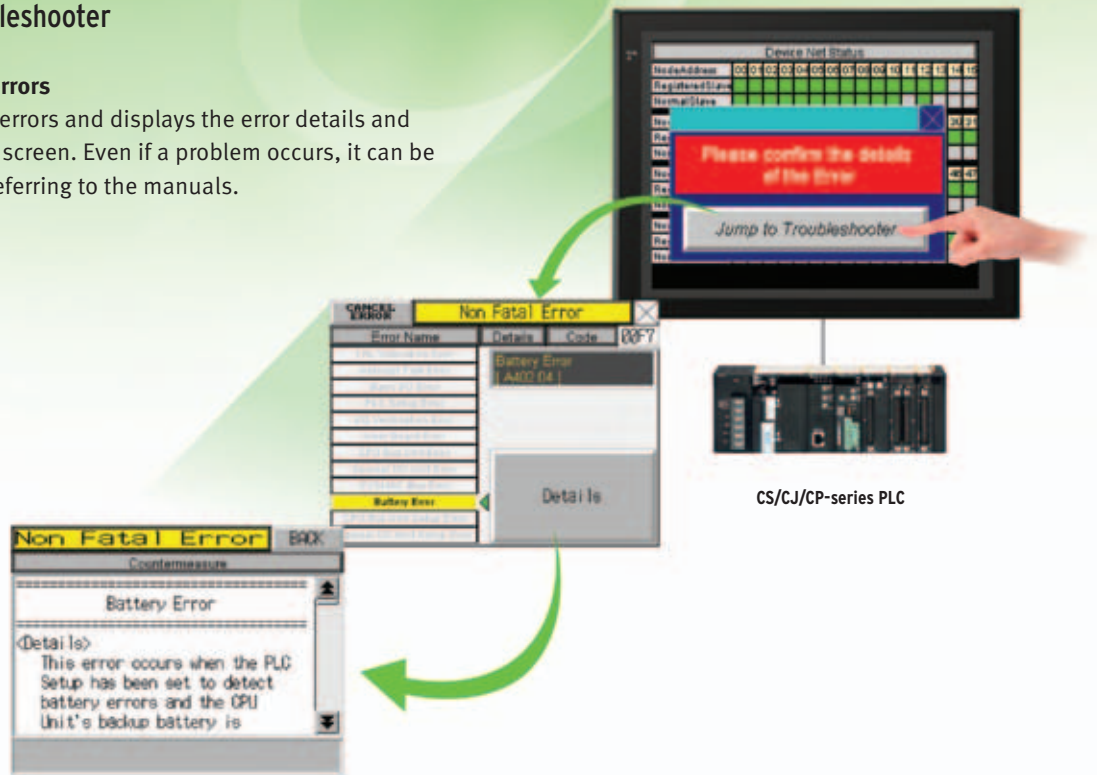

Machine Troubleshooter

Easier design of machine error screens

Individual error screens that were previously made for each error can now be integrated into one. It is possible to switch only the error details (text and screen) without ladder programming in conjunction with the alarm bit.

Specific example

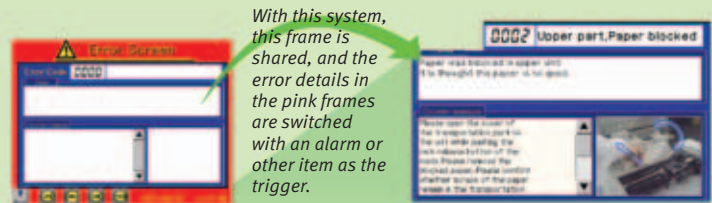

in conjunction with an alarm bit

Alarm bit 10.01 ON
(no paper)

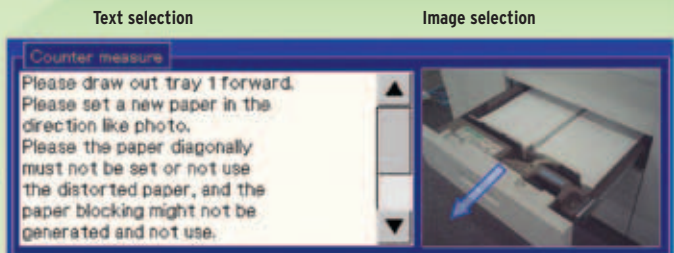

Alarm bit 10.02 ON
(printing error)

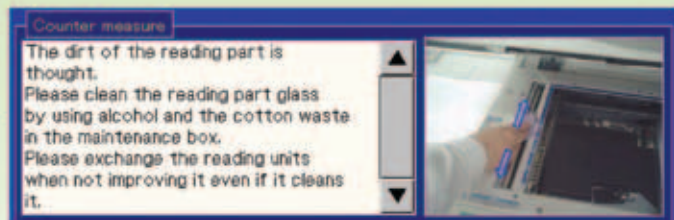

Best Match

NS Series is the most suitable HMI for the system that comprises Omron components. The advantage is the compatibility (reducing programming and screen data creation work), which will reduce the amount of designing work.

No Screen Designing / No Programming

NS



PLC CPU Unit monitoring screen



Device monitor

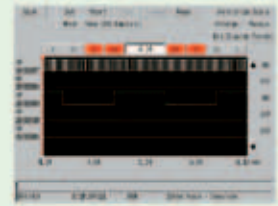

PLC Data Trace



Temperature controllers



PLC

CPU Bus units an Special I/O units

- SAP Library
- Troubleshooting

Remote I/O

Inverter

Vision Sensor

- 260,000-colour video input

Temperature Controllers

Servomotor Servo Driver

Smart Active Parts (SAP Library)

Significantly reduces the effort required to create ladder programming and screens. More than 3,000 library parts (Smart Active Parts) are available, which can directly access Omron PLCs and components. The objects can just be pasted from the Smart Active Parts (SAP Library) to the screen; it is completely unnecessary to create screens and ladder programming.

The temperature controller's setting and monitor screens are completed in no time.

SAP Library, Temperature Controller Parts

CX-Designer Screen Design Software

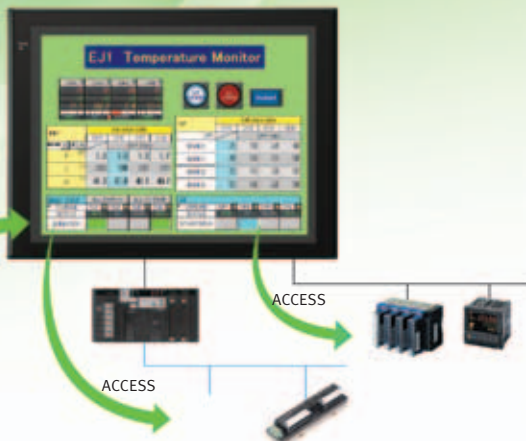

Example screens using support tool objects (Tool Function SAP Library)

Support tool objects can be incorporated to check for errors and make settings, even without a computer.

Plenty of support tool objects (the Tool Function SAP Library) are available, which can easily be incorporated into support tool functions in the NS-series HMI. Just paste the support tool objects in the screen to check for errors and make settings, even without a computer.

PLC CPU unit monitoring screen



NCF unit setting screen

DeviceNet monitoring screen

Computer support tools

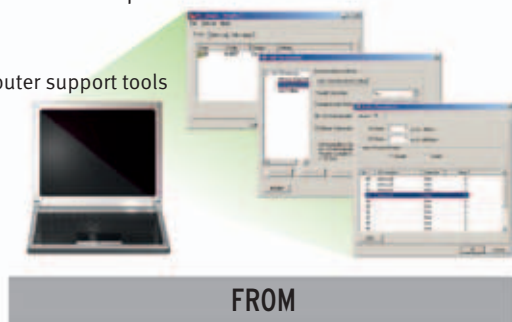

FROM

TO

CPU Bus unit and special I/O unit troubleshooting can also be performed with the SAP Library.

A Troubleshooter SAP Library is available to troubleshoot each Unit in the PLC. When an error occurs in a Unit, the Troubleshooter SAP Library provides an easy-to-understand explanation of the cause of the error as well as the countermeasures.

Troubleshooter SAP for a Position Control unit

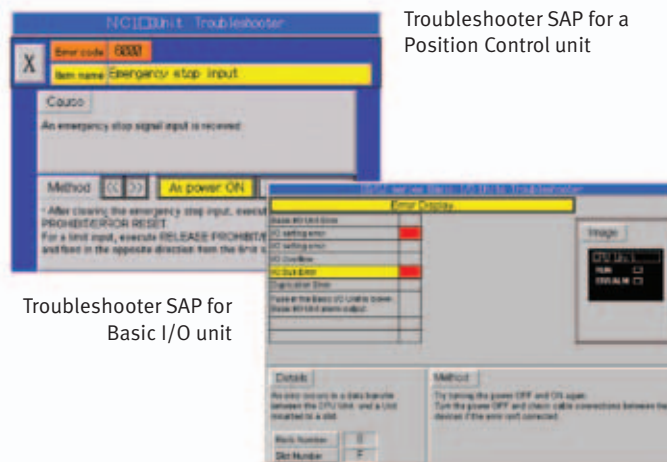

Troubleshooter SAP for Basic I/O unit

EtherNet/IP

Support for data structures This special feature is made possible by combining an Omron CJ2 PLC with an NS-series HMI. The data structures that you define on the Programming Tool can be used on the CX-Designer simply by dragging and dropping them.

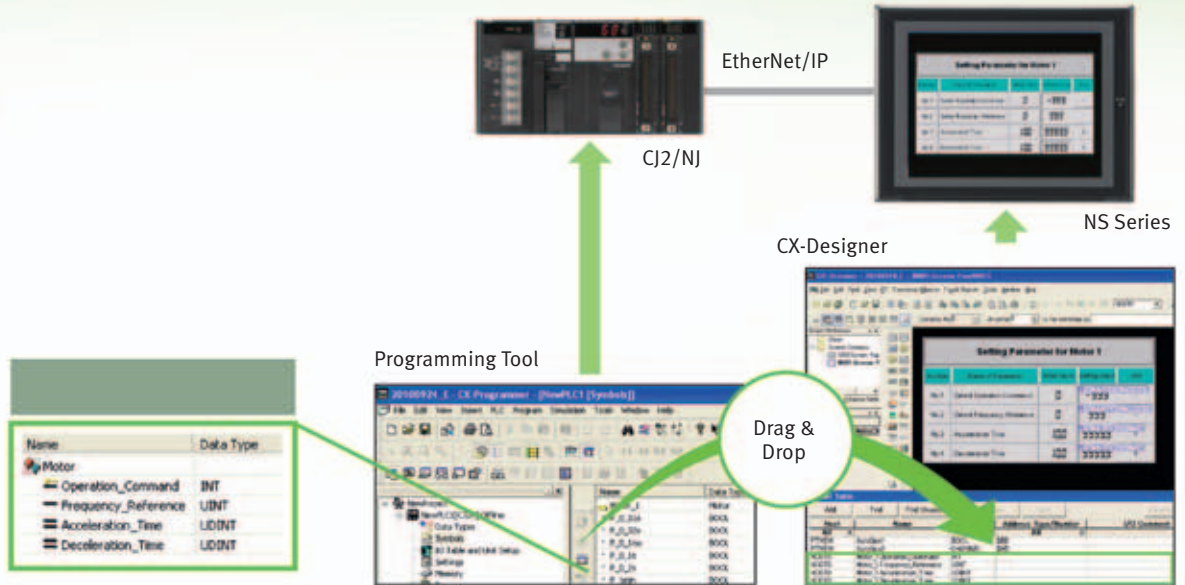

Tag access

A tag is a name given to an address. Tags are managed in the CJ2 CPU Unit, where they are defined as network symbols. The common user-defined tag names are used from programmable terminals and host applications to access memory in a CJ2 CPU Unit without knowing the physical address.

1. Tag names are managed at the PLC with the CX-Programmer.

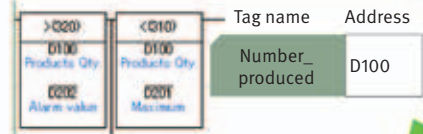

2. For example, create screens with tag names without typing the physical address.

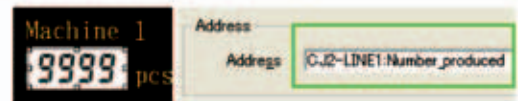

3. All devices will access with Common "Tag"

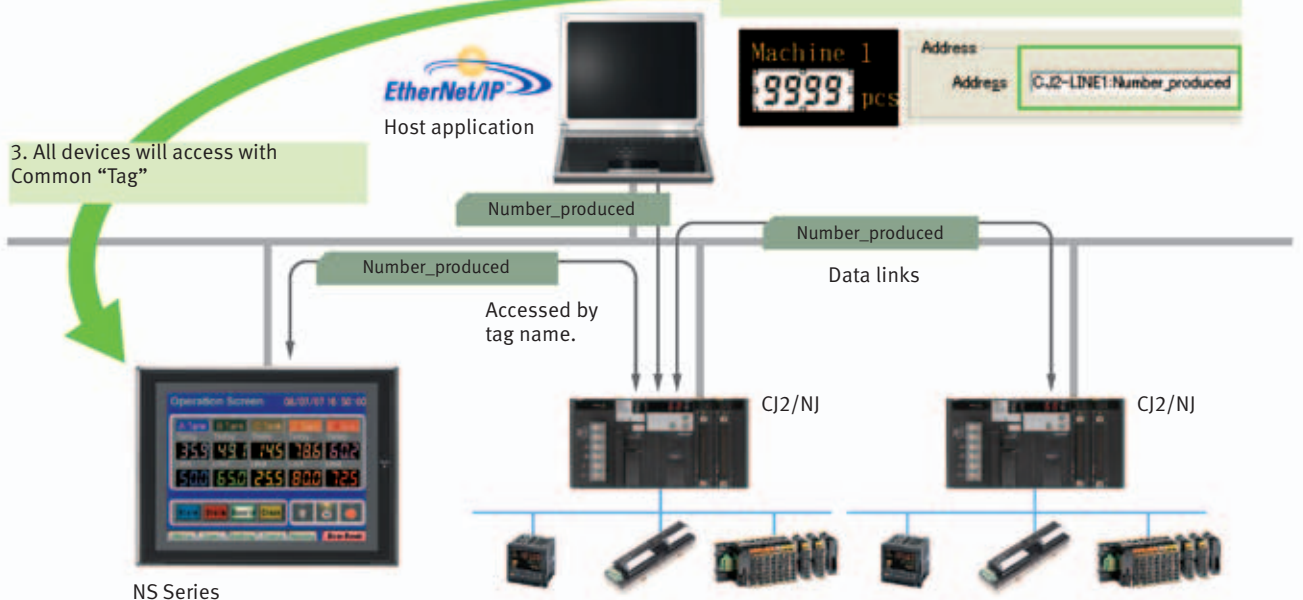

NS Series

Simultaneous and parallel engineering

The host applications can be designed using the tag names of the PLC and HMI. Parallel development will shorten the design time.

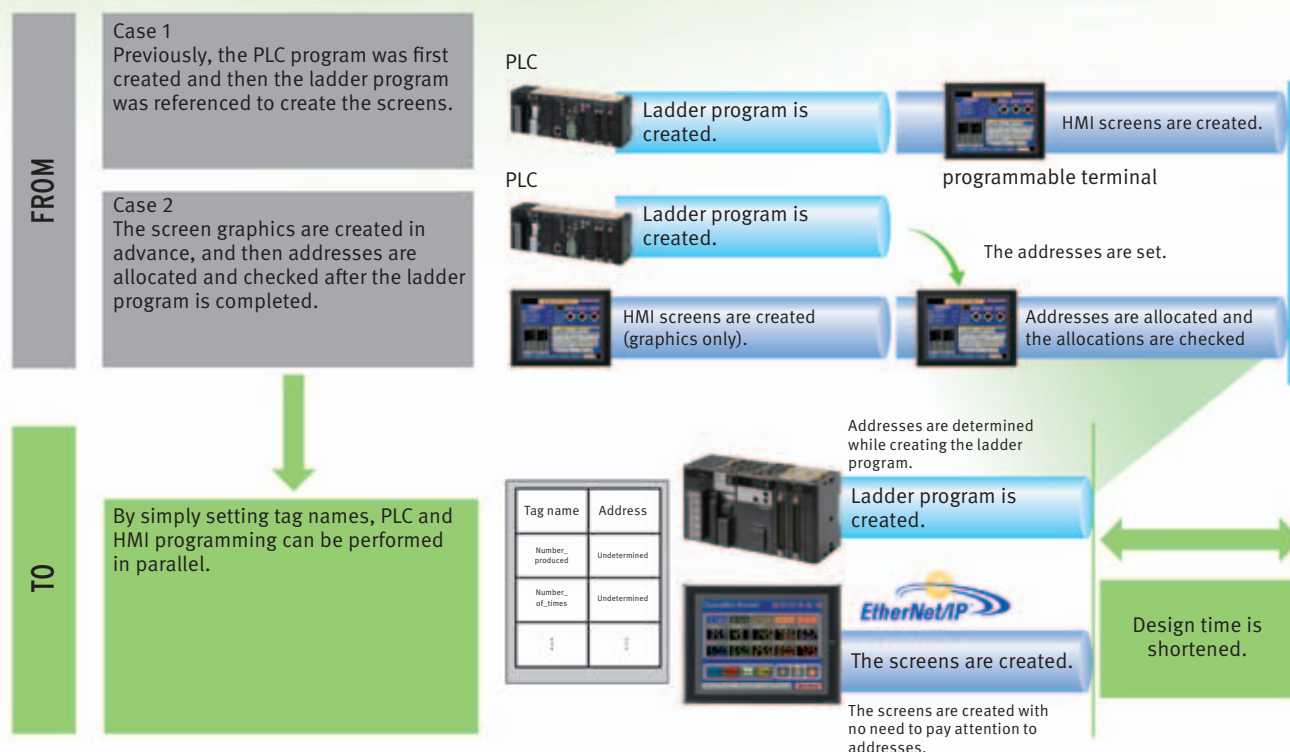

Minimize side effect of address changes

It is possible to access memory with tags, so the HMI and host application are not affected even if the address of data in the PLC is changed.

Specific example

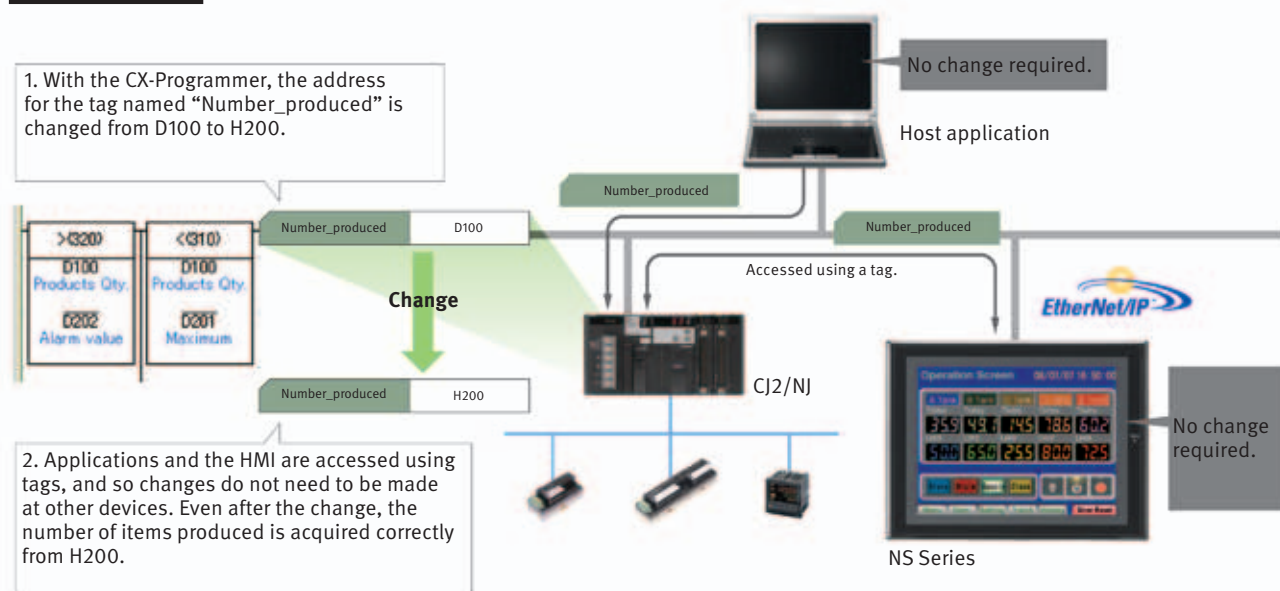

Direct Connection to temperature controllers

Connect Omron temperature controllers directly to the NS-series HMI.

Omron Temperature Controllers can be connected directly to the NS-series HMI's RS-422A. Data does not pass through the PLC, so ladder programming is not required. Also, there are plenty of objects in the SAP Library for temperature controllers, and temperature controller screens can be created easily just by pasting objects from the SAP library to the screens.

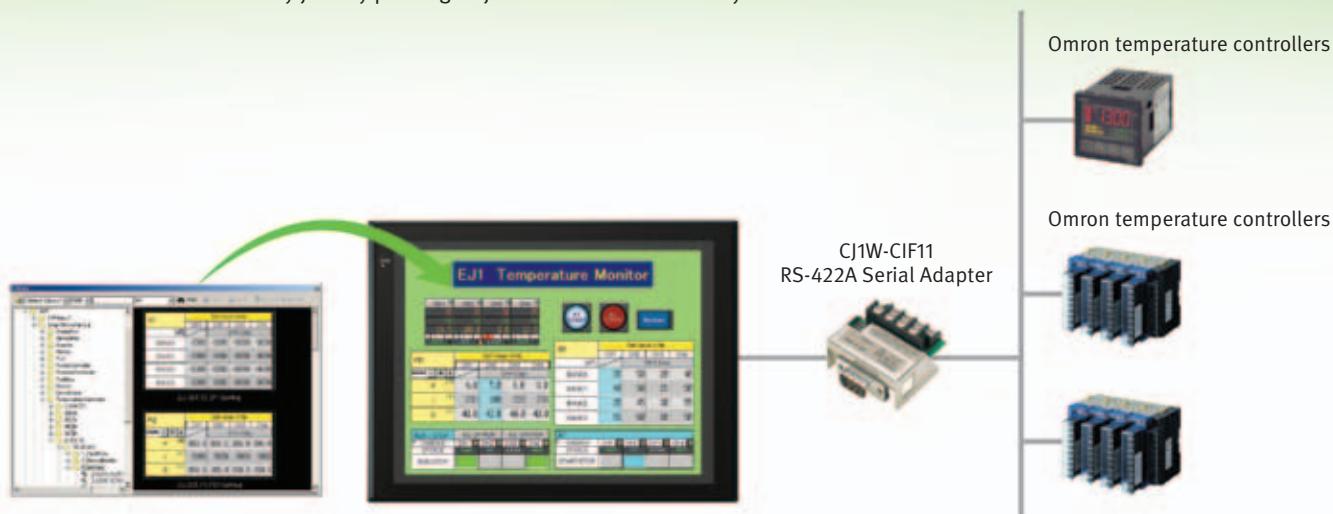

Multi-language Support

Support 42 languages and switch the language of the labels among up to 16 languages.

Unicode is supported and 42 Asian and European languages can be combined in screens. Also, it is possible to switch between up to 16 labels using the label switching function, so it is possible to support up to 16 languages in a single screen just by specifying the language to be displayed in each label.

Multi-language conversion is easy.

The screen data in the source language is exported to a CSV file and sent to a translation agency by e-mail for translation. Later, the translated CSV file is just imported to easily provide multi-language support.

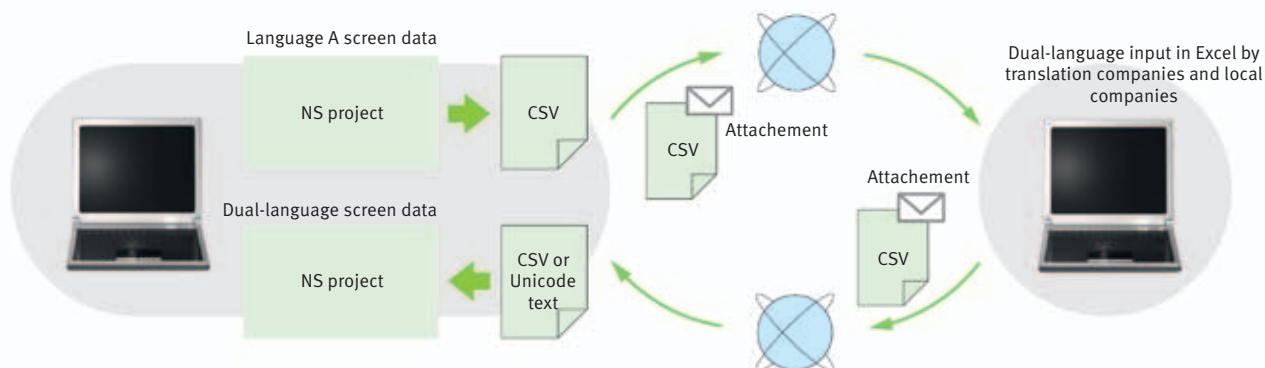

Data logger

Log large amounts of data using a personal computer. Data can be logged through background processing, with up to 160,000 points stored in one file. The logged data is stored in CSV format, and data can be displayed on data log graphs.



Example: 160,000 Points

Data can be logged for approximately 7.4 days, assuming data is logged every two seconds for 12 hours a day. By using automatic file saving, data logging can be continued even longer than 7.4 days.

Recipe handling

Checking machine data or switching processes from a host computer is easy. Parameter groups in the PLC can be transferred together to a computer, and the transferred data can be checked and edited in CSV format, e.g., using Excel. The edited data can then be transferred together back to the PLC.

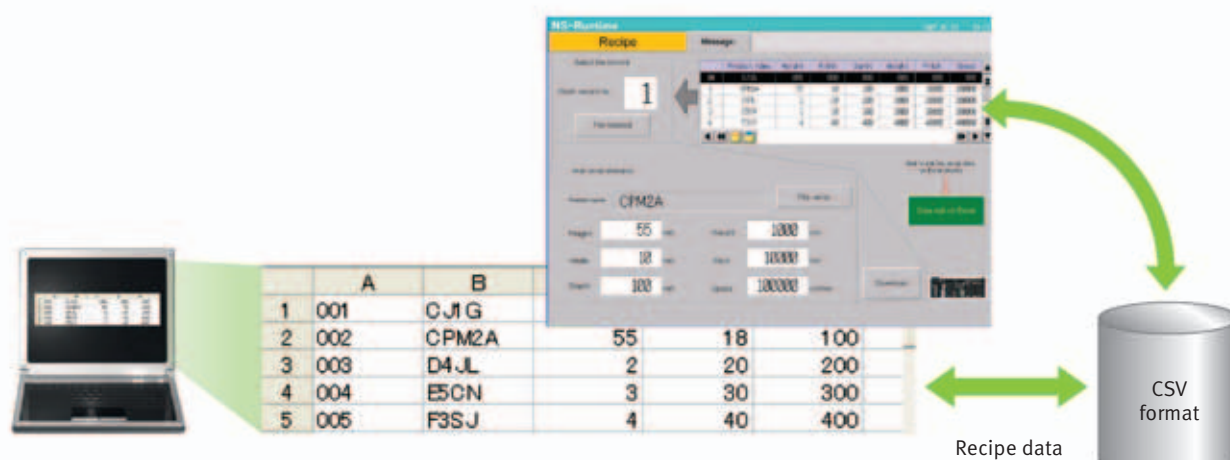

Screen data security functions

Protect important screen data with a password.

If password protection is set in the data transfer security settings when the screen data is designed, a password must be entered to download or upload the screen data, so important screen data can be protected.

Security password



A password between 4 and 64 characters long can be set. The download/upload will start if the user inputs the password that was designed. (Password input will be disabled if the wrong password is input 3 times in a row.)



If a password has been set, the password is required to transfer screen data (download or upload) with the Memory Card.

Device data transfer

Easy Data Exchange between the PLC and Components

For example, temperature controller alarm values can be transferred to the DM Area of the PLC's CPU unit. No communications programming or macros are required.

Multi-vendor support

Devices from multiple vendors are supported. Data can be easily exchanged with PLCs from other companies and Modbus devices.

Multi-vendor support

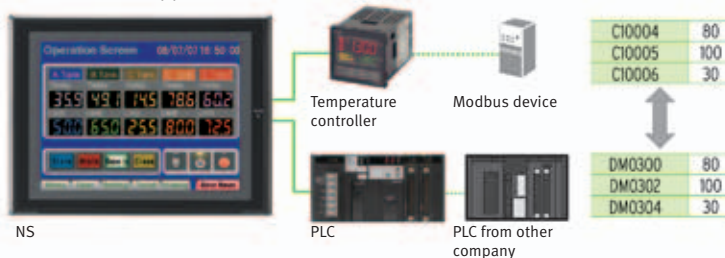

Easy settings

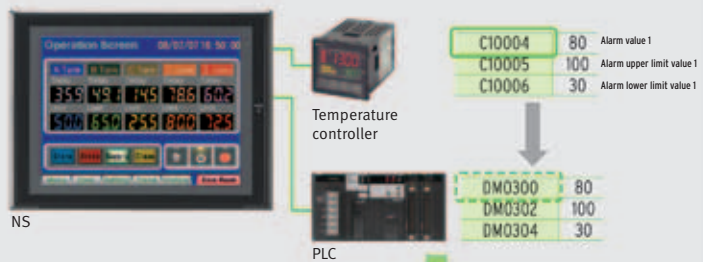

CX-Designer select device data transfer setting from the HMI menu.

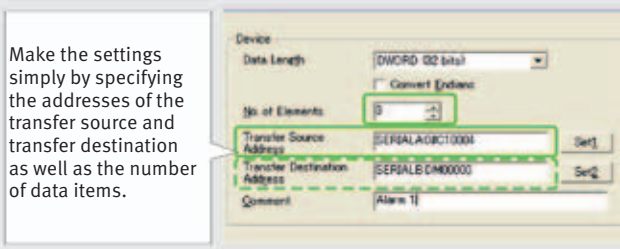

Make the settings simply by specifying the addresses of the transfer source and transfer destination as well as the number of data items.

Multi function

Execute up to 32 functions with one multifunction object.

Multifunction objects combine the functions of multiple objects into one object. Multiple functions can be executed by pressing one button without using troublesome macros. Setup is easy. For example, a setting can be made on-screen using the support software to turn ON a bit to start a machine, set a value and then change the screen.

Multifunction execution with one object

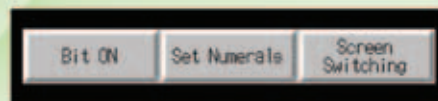

Integration



Execute multiple functions with one button.

Easy On-screen Setup with Support Software!

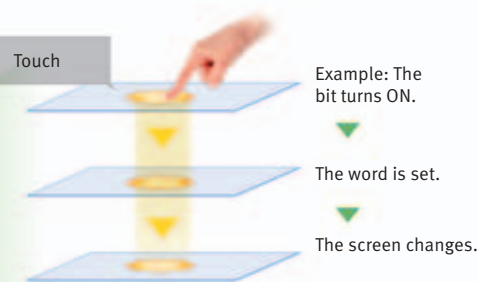
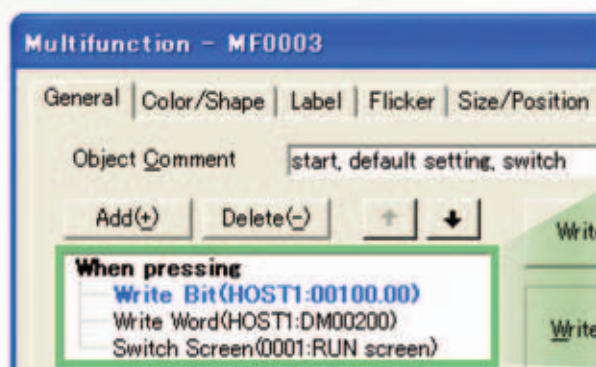

Multifunction objects support four useful functions

Switches that do not immediately operate when touched can be easily made without ladder programming.

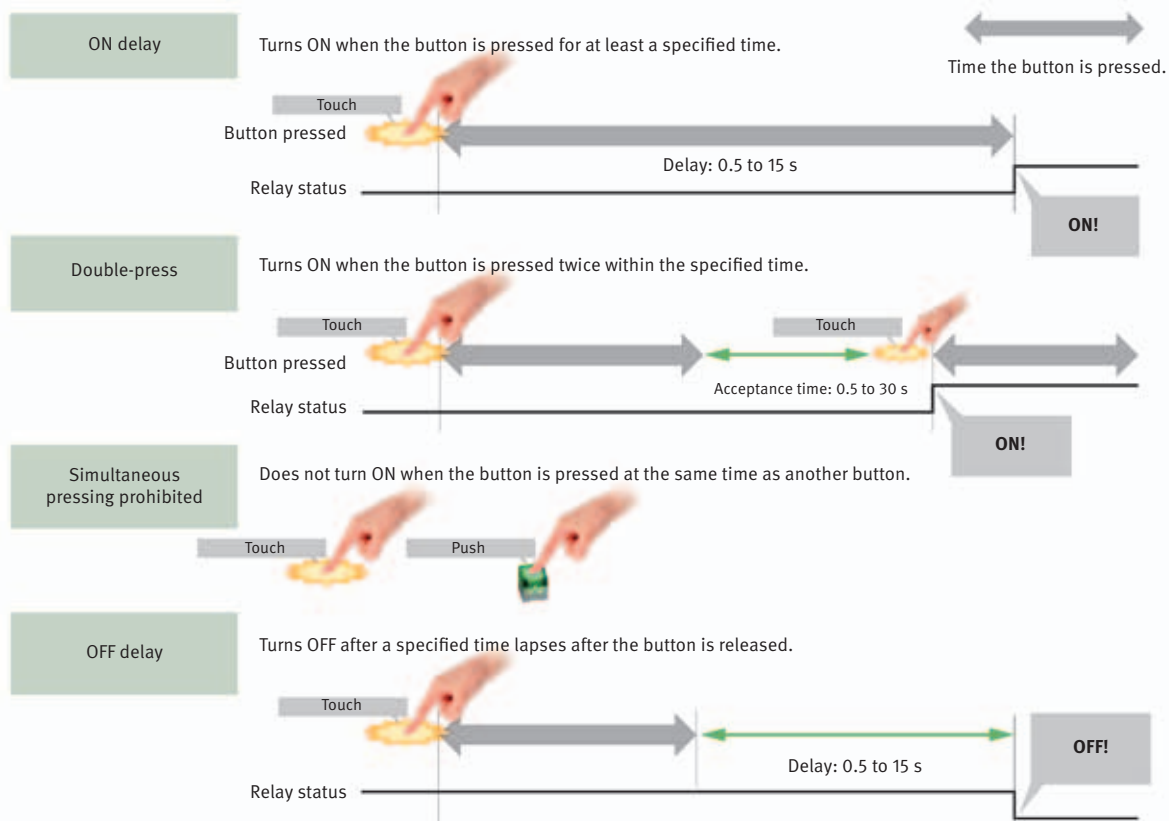

Versatile Graphs

Data Log Graph (Trend Graph)

Up to 128 data can be collected in the cycle of 500ms. Logging data is stored as a CSV file in the memory card inserted in the NS-series HMI.

Logging data is stored as a CSV file in the Memory Card mounted in the NS-series HMI. The data stored in the memory card can be read or deleted from the screen.

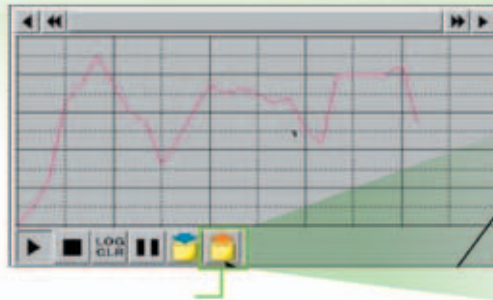

The log data files in the memory card appear as shown below when the read file button is pressed.

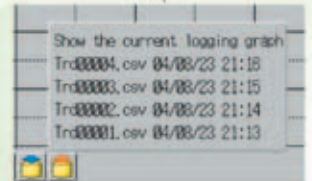

Suffixes are automatically added to file names set in the CX-Designer.

A log can be saved automatically, without any programming, just by selecting the Save the data periodically option in the data log setting window.



| | | |
|------------|----------|-------|
| LOG001.CSV | 04/06/04 | 10:00 |
| LOG002.CSV | 04/06/05 | 10:00 |
| LOG003.CSV | 04/06/06 | 10:00 |
| LOG004.CSV | 04/06/07 | 10:00 |
| LOG005.CSV | 04/06/08 | 10:00 |
| LOG006.CSV | 04/06/09 | 10:00 |
| LOG007.CSV | 04/06/10 | 10:00 |

Logging data for each day (43,200 points) is saved in the memory card in CSV format.

It is possible to make a one-week log by automatically saving the data seven times.

Line graph function

The data logged by the PLC can be displayed in overlapping graphs, so a device's operation can be compared for evaluation and analysis. In addition, up to 1,000 words of consecutive data can be displayed as a line graph, data can be displayed together and any region can be magnified.

(1) Graphs can be superimposed.



(2) The display can be magnified.

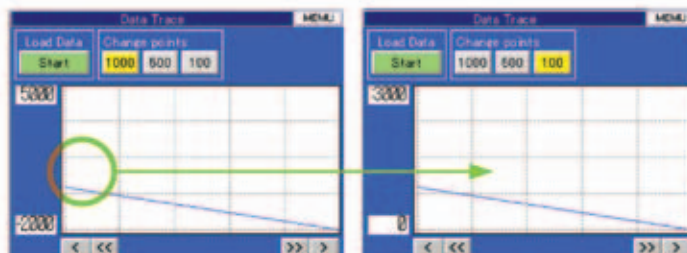

Continuous line function

Any position from the host (PLC) can be plotted as a graph. A graph can be plotted in any position by specifying the X and Y coordinates of the vertices. Also, the graph can be moved on the screen by specifying the movements from the PLC.

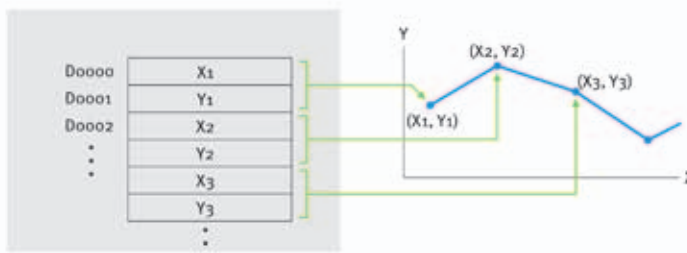

Good looking screens and objects

“Cool” screen templates

Professionally designed screen templates are provided. There are seven different types of attractive screen templates for different themes. Simply select the best template from the library.



“Cool” objects

Backgrounds, buttons, labels, message boxes, and other objects are also provided for various themes.



Screen Designer for NS Series, CX-Designer

User-friendly screen creation

Without screen creation and ladder programming, the CX-Designer Screen Design Software is so easy-to-use that anyone can master it. Quickly create the required screen by dragging and dropping objects. Omron's unified development environment lets you drastically reduce the work required to create screens.

All addresses and comments can be managed using a single Symbol Table.

Improved Icons and Help Shows a list of addresses, names, and comments used in project screen data. Addresses, names, and I/O comments for the CX-Programmer can also be imported.

| Host | Name | Type | Address | Type/Number | I/O Comment | Yes |
|---------|-----------|---------|----------|-------------|-------------|------------------|
| All | All | All | All | All | All | All |
| M012 | STOP | BOOL | | | STOP SWITCH | Network Variable |
| M013 | RUN | BOOL | | | RUN SWITCH | Network Variable |
| M014 | AutoStart | CHANNEL | 0000 | | | None |
| SERIALA | STOP | BOOL | DM0100 | | STOP SWITCH | None |
| SERIALA | AUTO | BOOL | DM000000 | | AUTO SWITCH | None |
| SERIALA | PARA | BOOL | DM000001 | | PARA SW | None |
| PTM01 | AutoStart | CHANNEL | 000 | | | None |
| PTM02 | AutoStart | BOOL | 000 | | | None |

Improved Icons and Help

The screenshot shows the CX-Designer interface with the following components:

- Project Workspace:** A tree view showing the project structure, including 'Sheet', '500 Sheet000', 'Screen Category', and various screen pages like '0000 Main menu', '0001 Language Selection', '0002 SAP Library Selection', '0003 Screen Page003', '0004 Data Log', '0005 Screen Page005', '0010 Multi-Lang. Numeral Val', '0011 Multi-Lang. Alarm', '0013 VIDEO Input ch1', and '0014 RGB Input Screen'.
- Property List:** Shows the properties for the selected object, 'Numeral Display & Input : NUM0011'. It includes fields for 'Item', 'Index', 'Value', 'Address', and 'Style'.
- Output Window:** Shows search results for the selected object. It includes a table with columns for Page, ID, Host, Name, Address, I/O Comment, Label, Object Comment, and Detailed Information.

The project Workspace enables the user to look through the entire project.

- Screens you want to edit can be opened right away.
- Perform screen management, such as copying or deleting screens, by simply right-clicking.
- Reusing screens from other projects is easy with the CX-Designer.
- Settings for alarms, data logs, communications, and other functions can be easily accessed.

Drastically reduce the number of clicks in the project.

Just click on the object once to display or change properties. Multiple objects can be selected to display and change shared properties all at once.

The Output Window shows search results.

In addition to addresses and I/O comments used in screen data, labels can also be used as search strings and the results can be displayed.

Reading the symbol table

The symbol table created in the CX-Programmer during ladder programming can be read into the CX-Designer by dragging and dropping, so it isn't necessary to manually enter data such as input addresses and I/O comments. Tags (i.e., network symbols) can also be read into the CX-Designer.

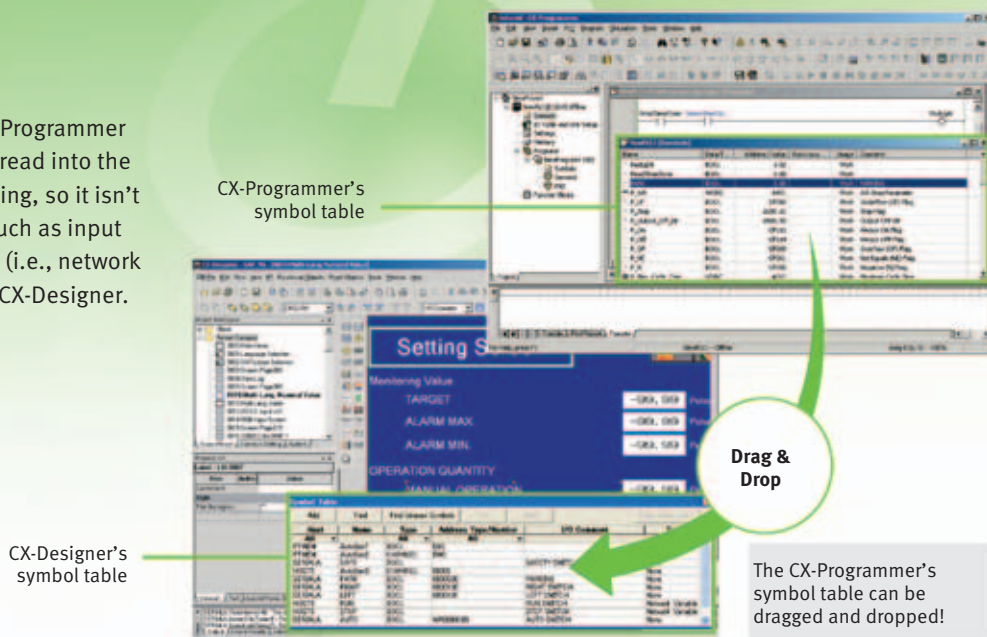

Example of Reading the Symbol Table

The symbol table read from the CX-Programmer can be directly dragged and dropped to the touch switch and lamp.

(1) Create a switch on the screen.



(3) Allocations for buttons and lamps can also be checked on the screen using comments imported from the CX-Programmer.



Example of easy address allocation

(2) Check the comment then drag-and-drop the symbol from the symbol table to the property list.

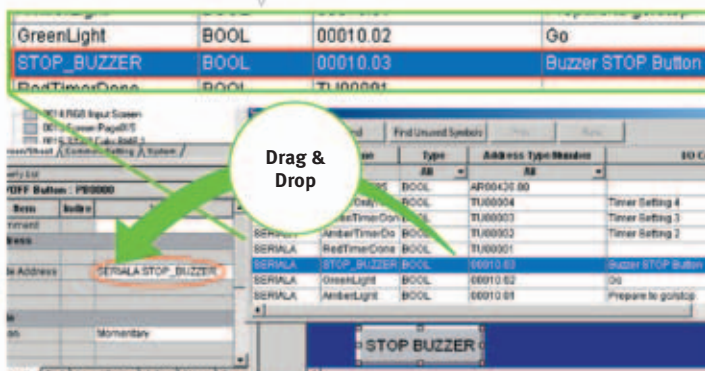

Example of reading I/O comments

If Use I/O comment is selected in advance for the Use symbol text as label, the I/O comments are automatically used as labels when addresses are dragged and dropped from the symbol table. (If Use symbol names is selected, the symbol names are used as the labels.)

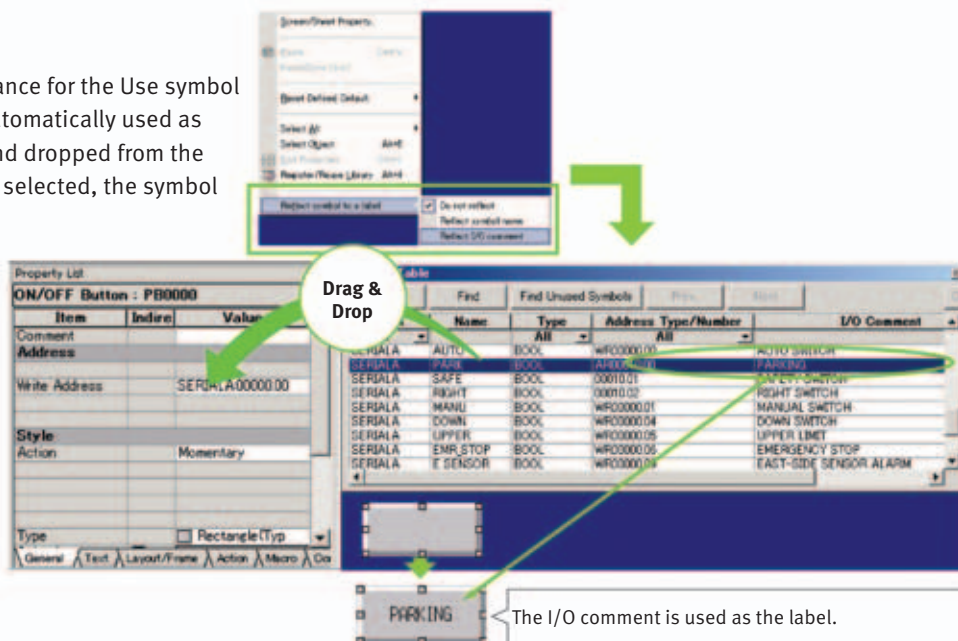

The I/O comment is used as the label.

Reading another project's screens and objects

Resources from another project can be easily reused by just selecting the screen or objects that you want to read and dragging and dropping it, so screens can be created intuitively.

Example screen 1

Select the screen that you want to read, drag it to the destination and drop it.

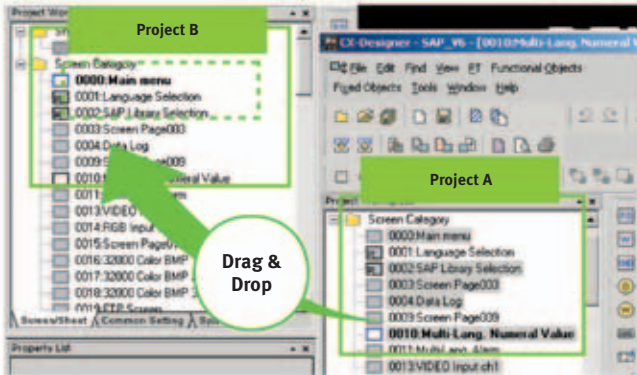

Example screen 2

Select the part that you want to read, drag it to the destination and drop it.

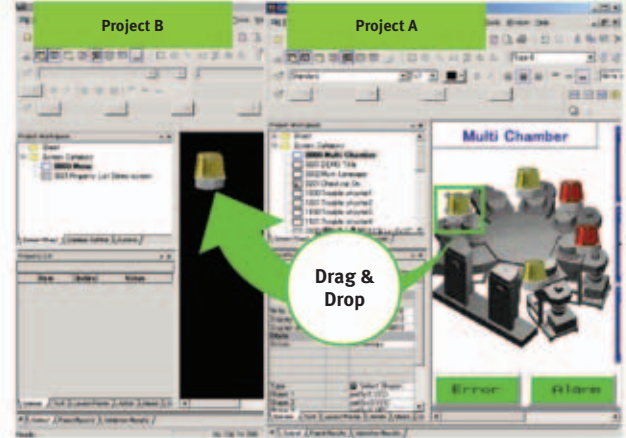

Reading CAD Files

It is possible to import DXF files by dragging and dropping them. The files are read as a diagram, and so less capacity is used than with images. It is also easy to customize the diagram by changing the shape or colour.

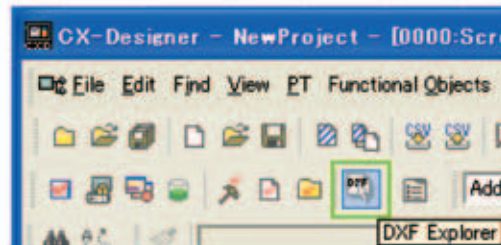

The screen data and ladder program can be checked simultaneously in the computer

The CX-Designer and CX-Programmer interconnects the test functions in the computer through the CX-Simulator. The screens and ladder program checks are performed simultaneously, which significantly increases debugging efficiency. The CX-Programmer also has a new button for integrated simulation. And, work efficiency is further improved with the ability to keep required work screens pinned on front and to zoom in or out as desired.

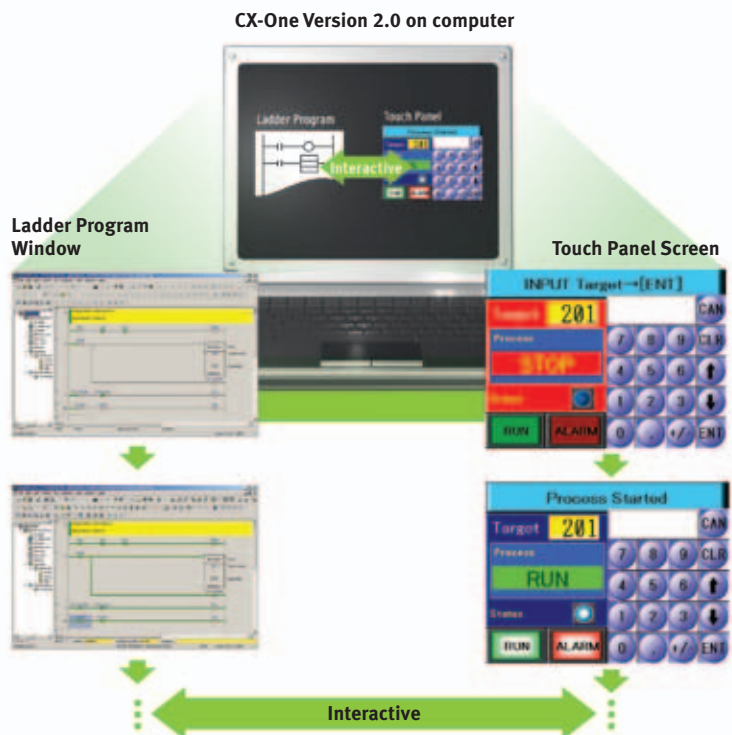

Editing of multiple objects

Addresses and other settings, such as labels and colours, can be set together in a list, making editing operations much more efficient. When the common attributes (such as background colour and text colour) of multiple parts are being changed, the attributes can be changed together using the property list.

Example screen 1 After editing the settings in the list, press the OK Button to make the new settings effective immediately.

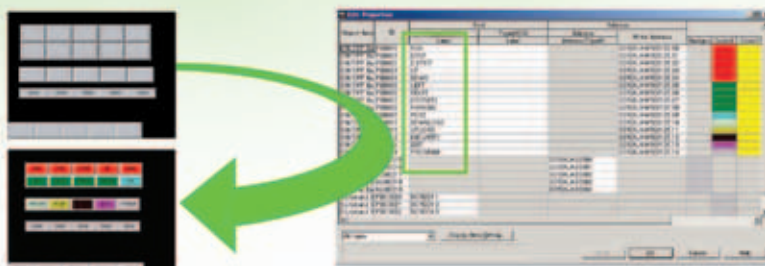

Example screen 2 If the background colour is changed from white to grey in the property list, the background colour is changed for all of the selected objects.

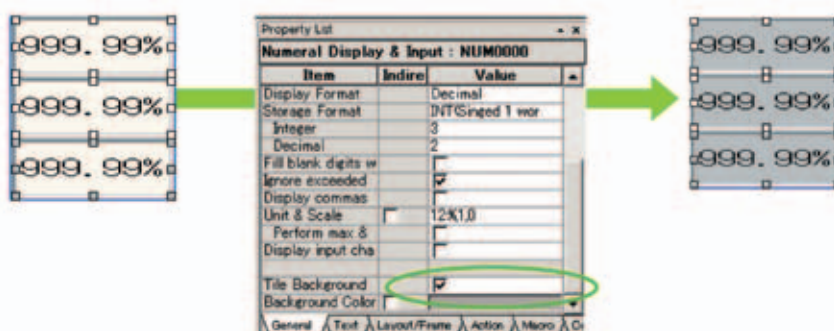

Editing of overlapping objects

The Select Object command is a powerful tool when you want to edit objects hidden by overlapping. A filter function can also be used to aid editing by displaying only the objects to be edited.

Object Selection Window

Right-click and select Select Part to display the objects (all types) on the screen.



Filter Function

Use the Select Part command's filter function to select the objects (ON/OFF Button) that you want to edit.

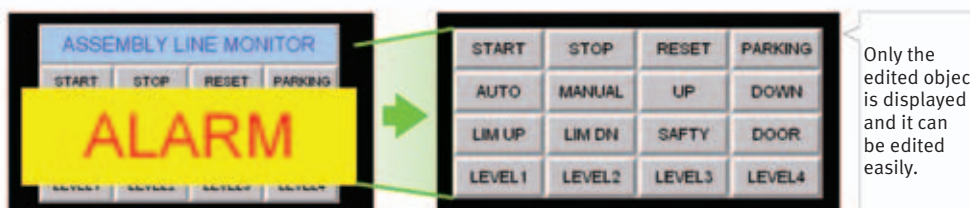

260,000-colour Video Display

NS-CA001 Video Input Unit Four video inputs or CCD cameras can be connected and up to four images can be displayed simultaneously if the image size is 320x240 pixels. The NS-CA001 cannot be used with the NS5 or the NS15.

NS-CA002 RGB/Video Input Unit There is an analog RGB input terminal in addition to the two video input terminals. Either of the video signals or the analog RGB signal can be displayed on the NS-series HMI. The NS-CA002 cannot be used with the NS5.

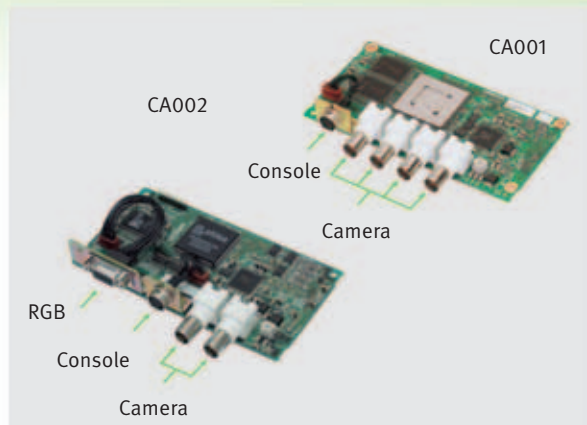

Also compatible with Omron Vision Sensors.

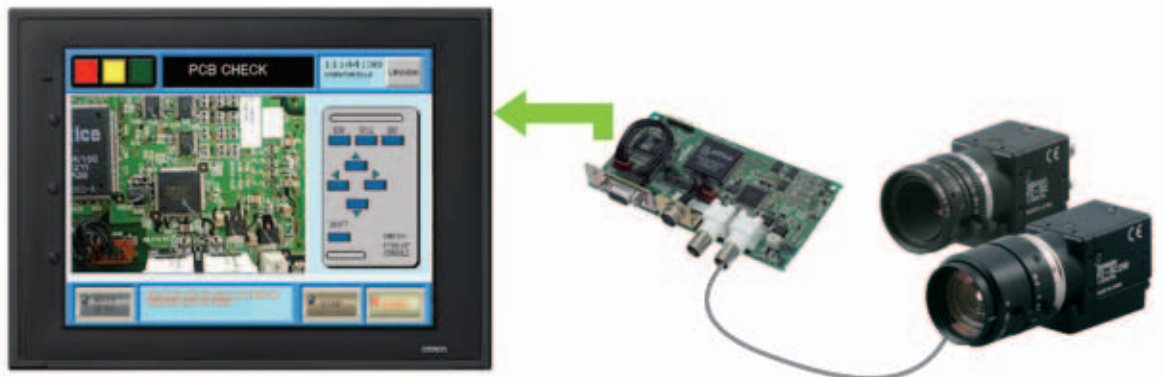

Analog RGB Output

The NS screen viewed on another monitor.

The NS15 screen (XGA) can be displayed on another on-site display that has RGB inputs.



FTP function.

FTP (File Transfer Protocol) allows texts, lists and recipes to be replaced with the put/get command from your computer! You can even replace BMP files.



WEB interface

Monitor and operate the full content of any NS screen on a connected web browser. You can control the full application running on the HMI and even retrieve the log files.



User security functions

Operator access rights and the operating format can be set to one of five password levels.

Each operator can be given one of 5 password levels using the User Security (level authentication) function. A password level can be set for each object, so various objects can be made inoperable or hidden based on the operator's access level.

Operator passwords are managed in 5 levels. Passwords can be up to 16 characters long and the access rights increase as the level number increases.

| Level | Operator Role | Access Level |
|---------|---------------|--------------|
| Level 1 | Line Operator | Low |
| Level 2 | Group Leader | Level 2 |
| Level 3 | Line Manager | Level 3 |
| Level 4 | Maintenance | Level 4 |
| Level 5 | Administrator | High |

The operator cannot manipulate objects with a password level (authentication level) higher than the operator's login level.

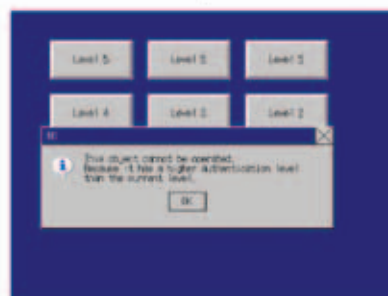

Single Port Multi Access (SPMA)

Transfer ladder program data to the PLC via the HMI. Perform online editing via the HMI.

[Computer (Serial/USB) -> NS-series HMI (Ethernet) -> PLC (Ethernet or Controller Link) -> PLC]

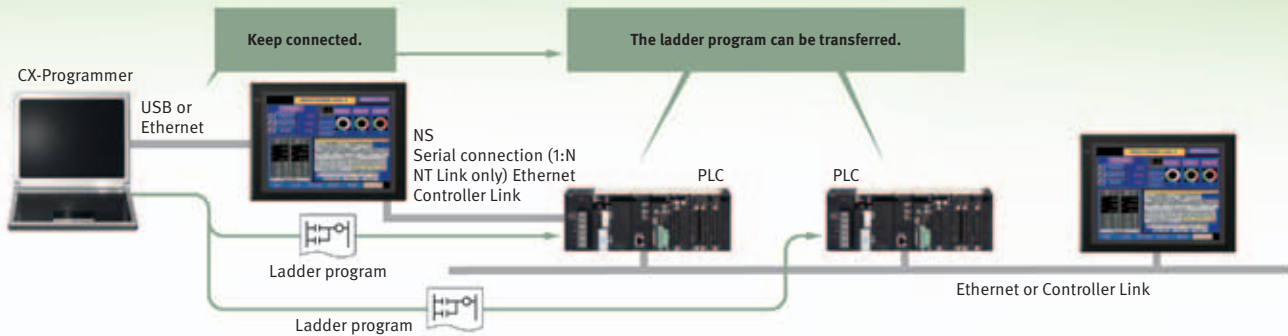

Transfer screen data via the PLC.

[Computer (Serial) -> PLC (Ethernet or Controller Link) -> NS-series HMI]

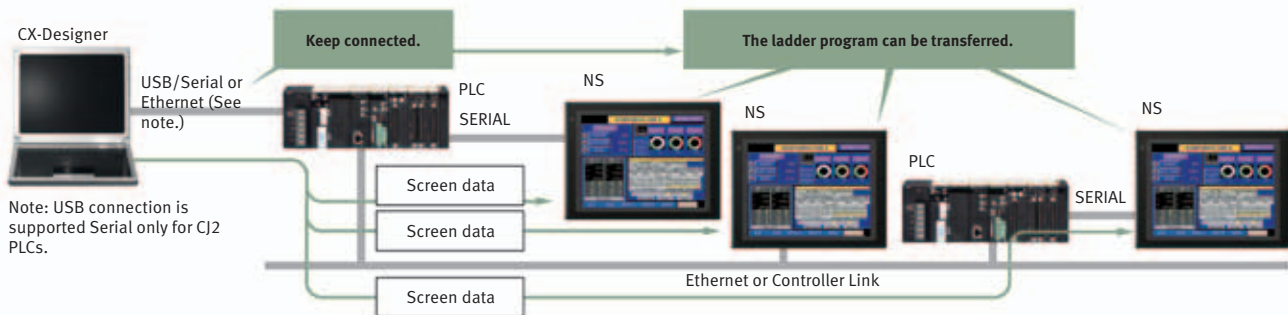

Note: USB connection is supported Serial only for CJ2 PLCs.

Note: SPMA can be used in CS/CJ-series PLCs with lot number 030201 or later.

Note: SPMA via a PLC is not supported when a CP-series PLC is connected. (SPMA via an NS-series HMI is supported with a CP-series PLC.)

Easy automatic connection

A search is automatically made for the PLCs connected to the HMI and the results are displayed using the automatic online connection function in the CX-Programmer. Just select a PLC from the list to connect. This function is also supported for PLCs over network layers.

PLCs registered to the HMI are automatically searched for. Make the connection simply by selecting from the PLC list.

CX-Programmer

Note 1: SPMA can be used in CS/CJ-series PLCs with lot number 030201 or later.

Note 2: SPMA via a PLC is not supported when a CP-series PLC is connected. (SPMA via an NS-series HMI is supported with a CP-series PLC.)

Note 3: CX-Programmer version 8.2 and higher support automatic online connection via the HMI. NS system version 8.2 or higher is required.

Automatic search

PLC Data Trace

The PLC data trace function can be used without a computer.

The PLC Data Trace function is built into the HMI in addition to the Ladder Monitor and Device Monitor. A bit's status and operation can be viewed in a time chart just by setting the desired PLC bit's address in the HMI. It is also now possible to display word data, save data in CSV files, and save time chart screens in BMP files.

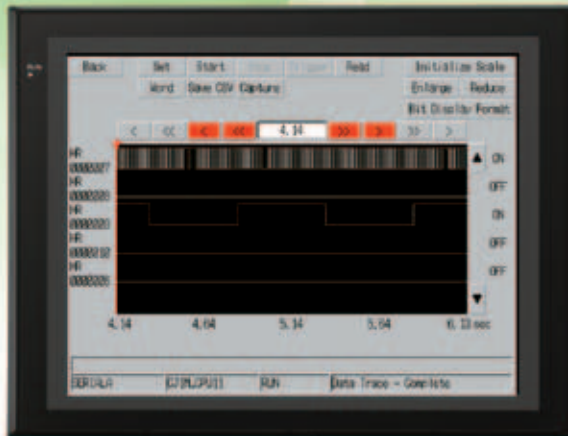

Note 1: There are differences between this Data Trace function and the CX-Programmer's Data Trace function. Refer to the NS-series Programmable Terminal Programming Manual (Cat. No. V073) for details.
 Note 2: The PLC data trace function cannot be used with the 5.7-inch model.
 Note 3: The PLC data trace function is not supported for connection with a CP1E PLC.

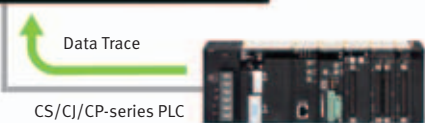

Operating log

What was touched, when and by whom?

Functionality has been improved with the addition of a log to record operators' use of the panels. It is now possible to record and display the time, date, and operation details for buttons (i.e., hardware switches) pressed on the control panel in addition to operations on the touch panel. The operation log can be saved in a CSV file on a memory card mounted in the NS-series HMI.

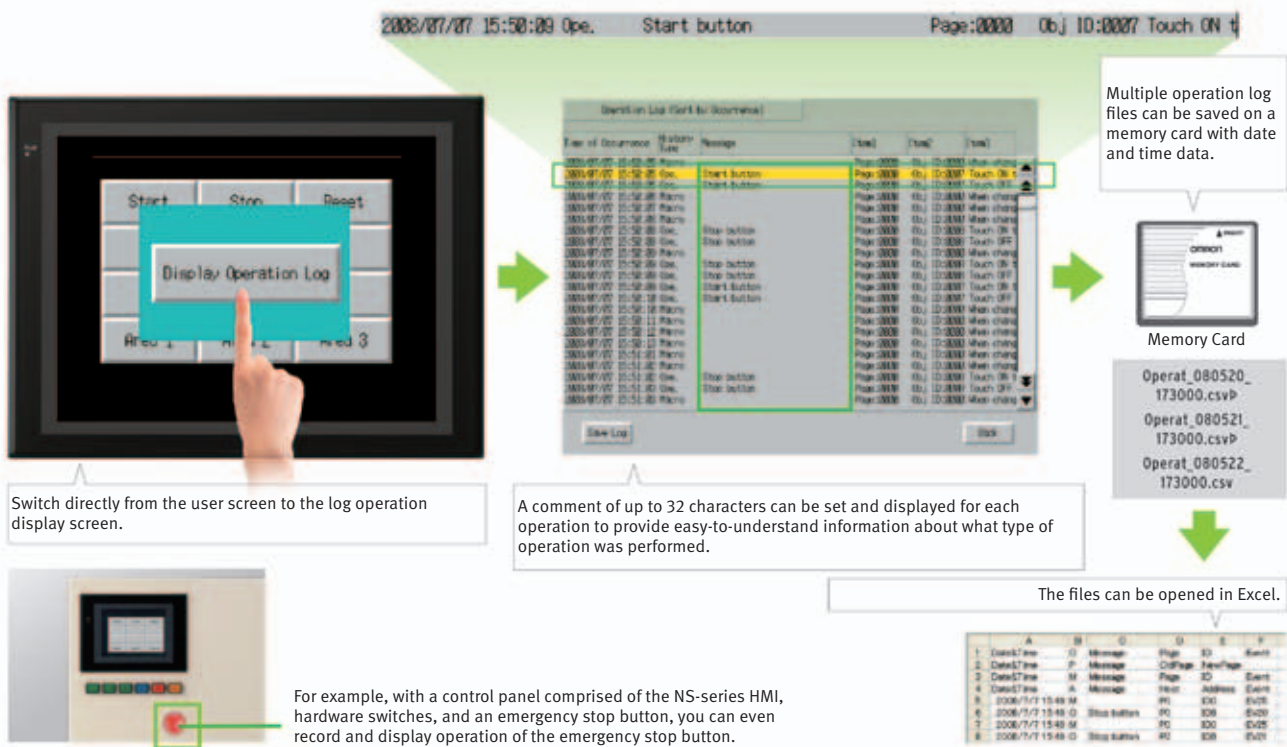

Ladder monitor

The ladder program can be monitored without a computer. Ladder programs with I/O comments can be monitored on the HMI's screen and the ladder program can also be edited with the Programming Console function.

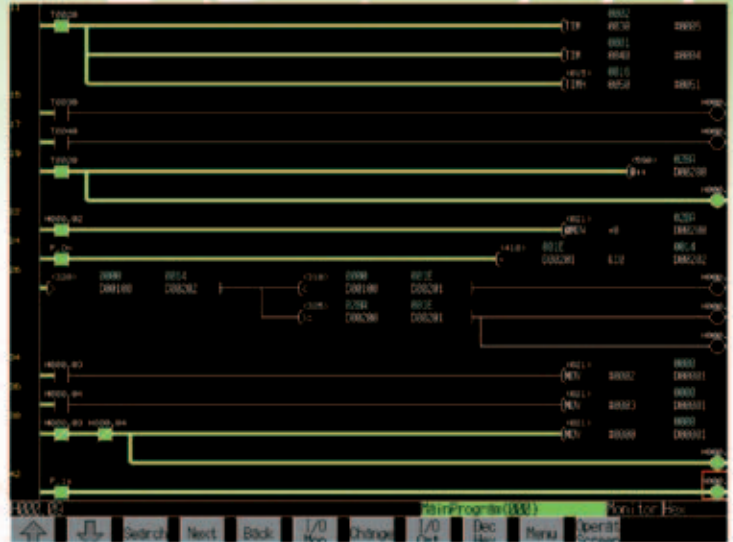

Also meets the requirements of users who need to display devices onsite

Switch Box function

The operator can check the PLC status by displaying just the I/O comments and status.

Device Monitor function

Displays the device's contents, allowing settings to be input and checked and making startup operations more efficient.

Switch Box function

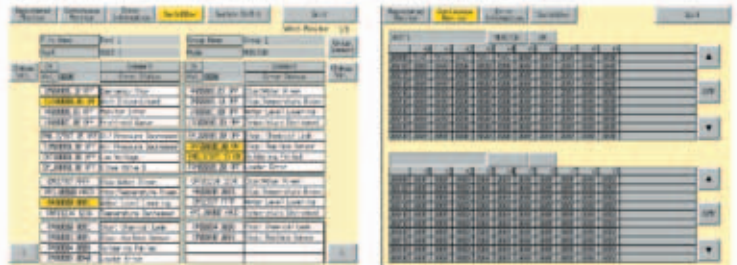

Easy checking the alarm bit and shortens searching time.

When an alarm occurs, touch the message to automatically search for the alarm bit (output bit) for the alarm. This enables you to quickly check the alarm address and investigate why the bit turned ON.

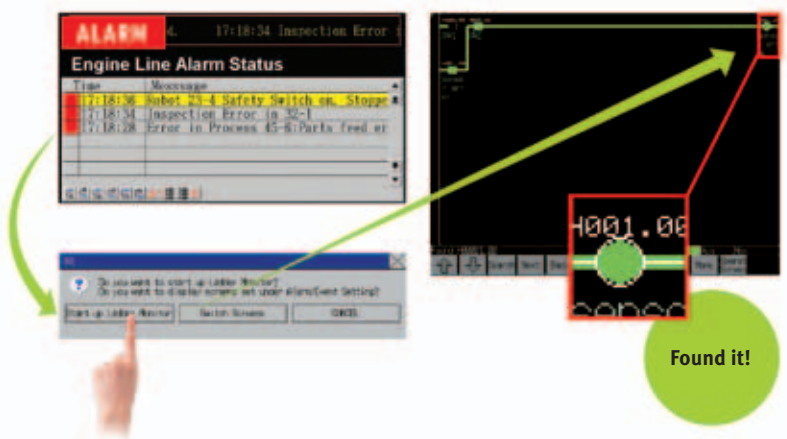

“Find Back”, “Find Next”, useful function supported by the NS-series.

Reduced Time to Investigate Which Output or Input Is Causing the Problem.

| Device Monitor function | Operation with NS-series HMI | CX-Programmer |
|---|------------------------------|---------------|
| Find the address at specified by the cursor. | Next | “N” Key |
| Find the output from the input bit or find the input bit from the output at the cursor. | Double-click | “Space” Key |
| Return to the previous search position. | | “B” Key |

Force-setting and force-resetting are possible

Locations that have been force-set are displayed in pink and can be checked at a glance.

Check and change I/O While You View the Ladder Diagram on the I/O Monitor

Display and change the present value by specifying the address. It is also possible to force-set/reset bits with the I/O monitor.

Note: The Ladder Monitor function is not supported by the 5.7-inch models.

NS-NSRCL (NS-Runtime)

Achieve machine/line monitoring and data logging on your office computer.

Machine Viewer

Machine viewer in an office environment. There is no need to create complex host applications. Moreover, when an alarm occurs, a PDF file can be displayed as maintenance information. NS Series screens can be reused on the computer and screens can be also newly created independently of touch panels at the production site.

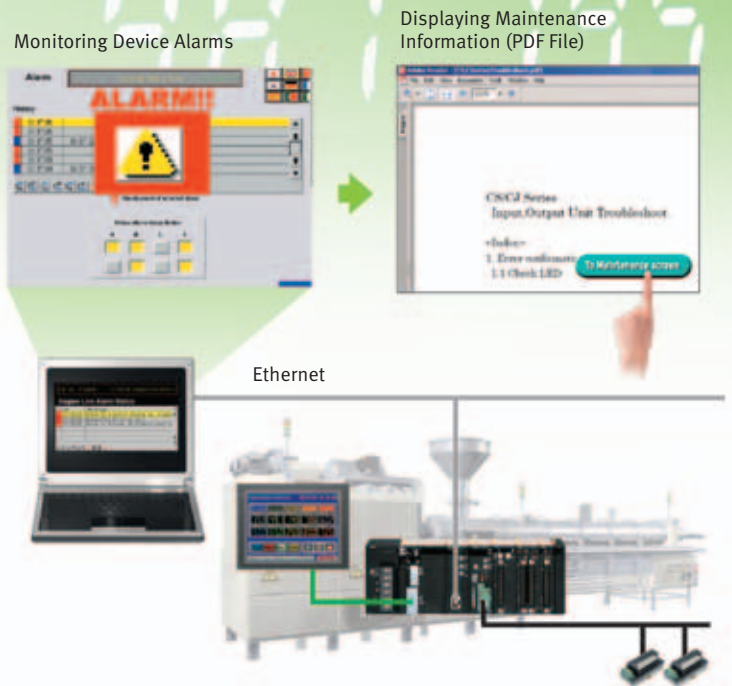

Wide Screen

Computer output can be displayed on another wide-screen monitor. XGA (1,024 x 768 dots) and up to a maximum screen size of 3,840 x 2,400 is supported. Alarms occurring in devices or the line can be monitored.

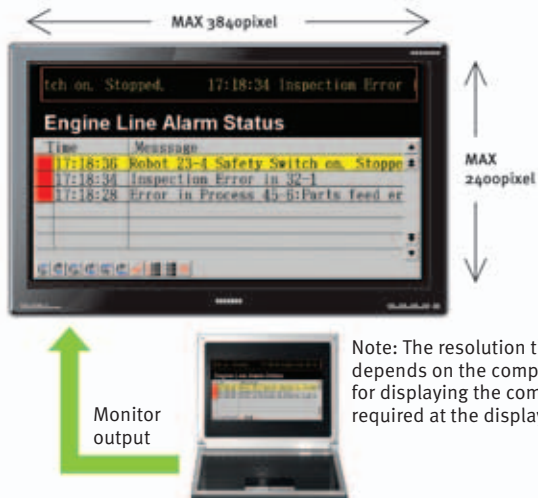

Note: The resolution that can be displayed depends on the computer. An input function for displaying the computer screen is required at the display monitor.

Data logger

Log large amounts of data using a personal computer. Data can be logged through background processing, with up to 160,000 points stored in one file. The logged data is stored in CSV format, and data can be displayed on data log graphs.

Example: 160,000 Points

Data can be logged for approximately 7.4 days, assuming data is logged every two seconds for 12 hours a day. By using automatic file saving, data logging can be continued even longer than 7.4 days.

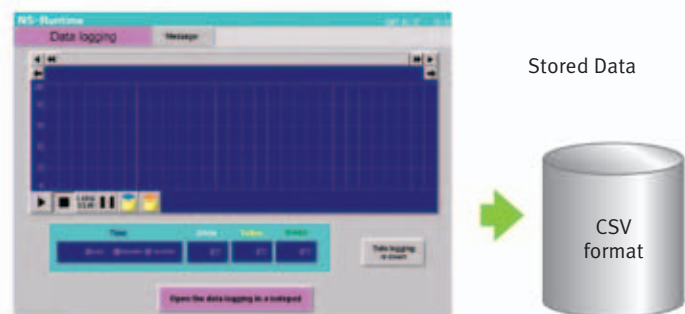

Recipe handling

Checking machine data or switching processes from a host computer is easy. Parameter groups in the PLC can be transferred together to a computer, and the transferred data can be checked and edited in CSV format, e.g., using Excel. The edited data can then be transferred together back to the PLC.

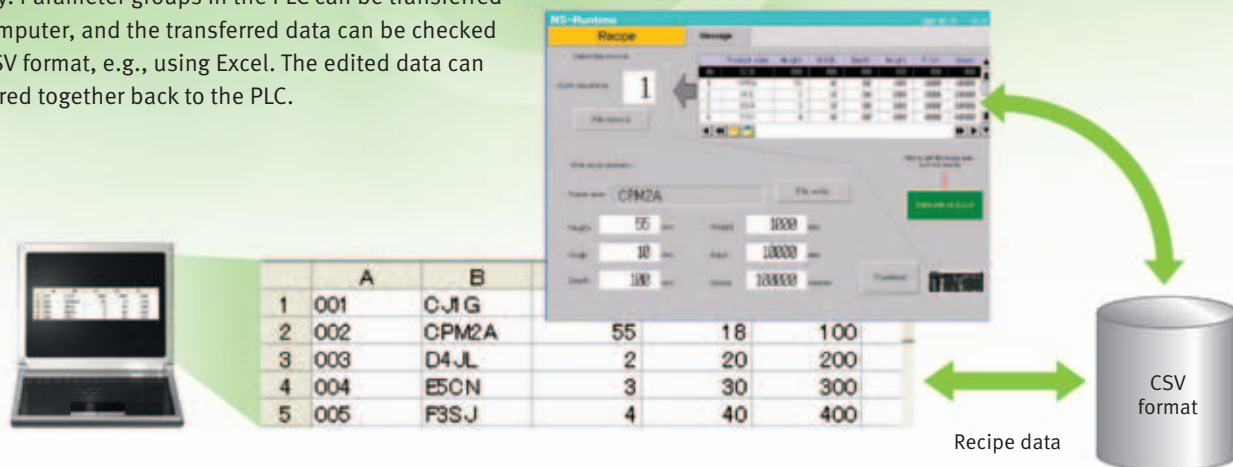

Easy installation

To get started, just install the NS-Runtime in the computer and place the screen data in the applicable folder. NS/NSJ-series screens and NS-Runtime screens can all be managed using one single tool.

Note: The NS-Runtime will operate in a computer environment even if the CX-Designer is not installed. The hardware key (USB dongle) that is supplied with the NS-Runtime is required for operation.

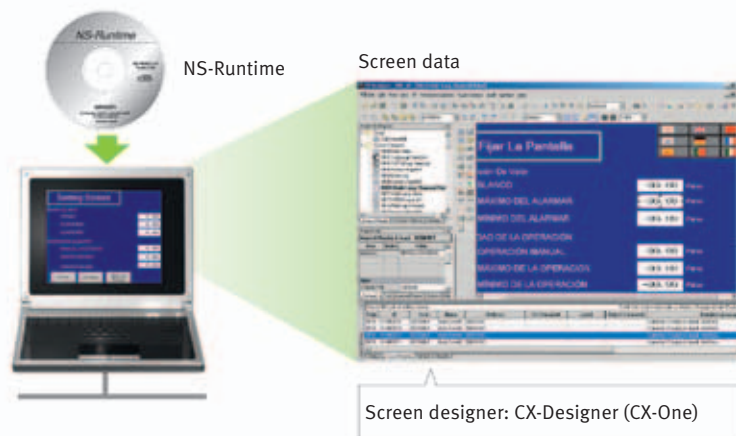

Application startup function

User applications can be started from NS-Runtime. Applications can be started simply by pressing buttons on the screen.

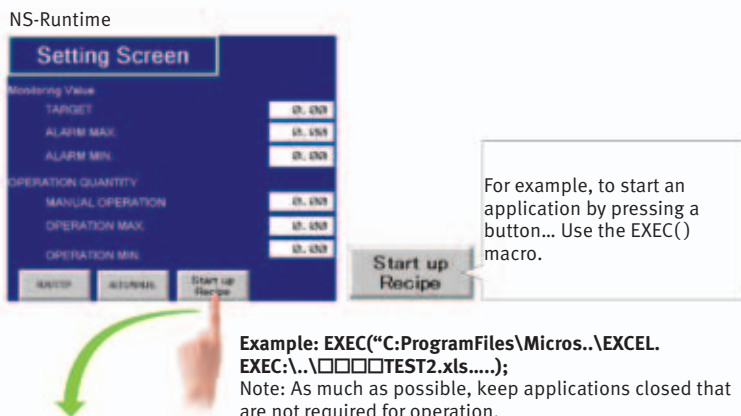

- Note 1: If the screen data is converted from the NS Series, NS-Series HMI system versions must be 8.1 or lower.
- Note 2: Do not use this product for 24-hour operation in an FA environment. Omron shall not be responsible if the computer or application does not operate properly due to noise or other causes. Omron shall not be responsible for any problems that may be caused by any applications other than Omron products.

| | A | B | C | D |
|---|----------------------------------|-----------|--------------|-------|
| 1 | Setting Item | Parameter | Pressure | Oil W |
| 2 | Common parameter | 1 | 600 | 600 |
| 3 | Production unit | 2 | 700 | 700 |
| 4 | Frequency of occurrence of alarm | 3 | 800 | 800 |
| 5 | | 4 | 900 | 900 |
| 6 | Read from PLC | | Write to PLC | |
| 7 | | | Print | |

HAND-HELD HMI

NSH5 Series

A hand-held version of the NS5 is now available to perform operations at the production site. The NS-series HMI's have a complete set of functions that can be used at the production site, such as the SAP Library, multi-language support, and Programming Console functions.

Function Switches
Use the ten functions switches. F1, F2, F6, F7: Wired outputs F3 to F5, F8 to F10: Communications outputs

Memory Card Interface and USB Slave Connector.

Emergency Stop Switch.
3PST-NC Structure
DPST-NC: Increase safety (wired outputs). SPST-NC: Input to internal NSH5 memory, output to a lamp for emergency stop switch operation, or output via communications, e.g., to a PLC.

Water Resistance to IP65
The water-resistant structure is equivalent to IP65 on all surfaces. The HMI may not be suitable for use in environments with long-term water exposure.

HMI and Cable Sold Separately
Select the Cable according to the application (RS-232C/RS-422A). Connector-loose wires, UL connector, 3 m or 10 m.

3-Position Enable Switch
Increased safety with DPST-NO structure (wired outputs).

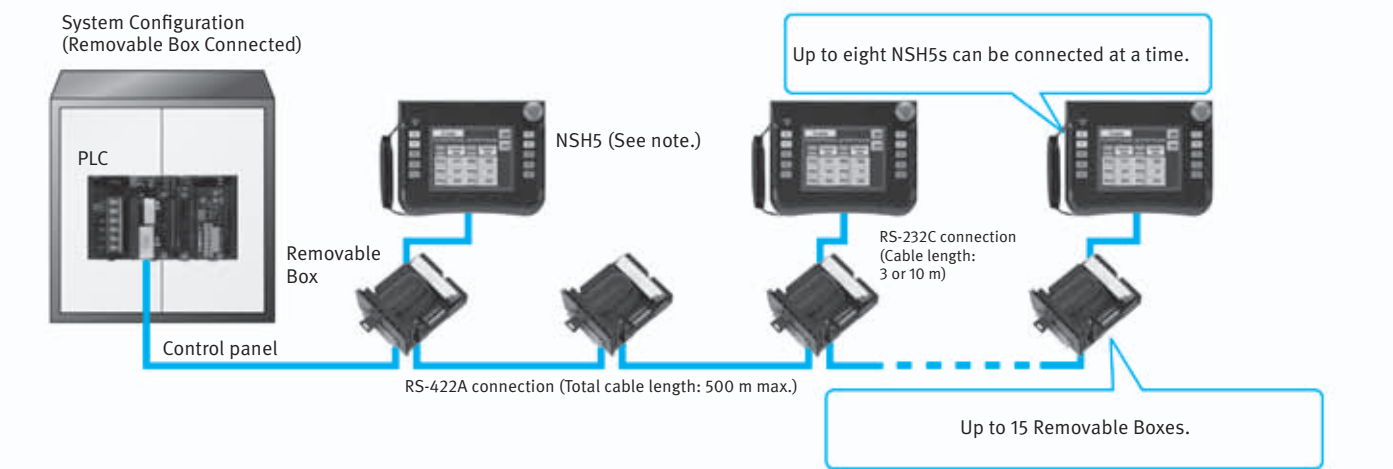

Ordering Information

International Standards

- The standards are available as follows: U: UL, U1: UL (Class I Division 2 Products for Hazardous Locations), C: CSA, UC: cULus, UC1: cULus (Class I Division 2 Products for Hazardous Locations), CU: cUL, N: NK, L: Lloyd, and CE: EC Directives.
- Contact your OMRON representative for further details and applicable conditions for these standards.

Programmable Terminals

| Product name | Specifications | | | | Model | Standards |
|----------------------|--|------------------|----------|---------------------------------------|----------------|-------------------------------|
| | Effective display area | Number of dots | Ethernet | Case color | | |
| NS5-V2 *1 | 5.7-inch STN monochrome | 320 × 240 dots | No | Ivory | NS5-MQ10-V2 | UC1, CE, N, L, UL Type4 |
| | | | | Black | NS5-MQ10B-V2 | |
| | | | Yes | Ivory | NS5-MQ11-V2 | |
| | | | | Black | NS5-MQ11B-V2 | |
| | 5.7-inch TFT color LED backlight | | No | Ivory | NS5-SQ10-V2 | |
| | | | | Black | NS5-SQ10B-V2 | |
| | | | Yes | Ivory | NS5-SQ11-V2 | |
| | | | | Black | NS5-SQ11B-V2 | |
| | 5.7-inch High-luminance TFT color LED backlight | | No | Ivory | NS5-TQ10-V2 | |
| | | | | Black | NS5-TQ10B-V2 | |
| | | | Yes | Ivory | NS5-TQ11-V2 | |
| | | | | Black | NS5-TQ11B-V2 | |
| NS8-V2 | 8.4-inch TFT LED backlight | 640 × 480 dots | No | Ivory | NS8-TV00-V2 | UC1, CE, N, L |
| | | | | Black | NS8-TV00B-V2 | |
| | | | Yes | Ivory | NS8-TV01-V2 | |
| Black | NS8-TV01B-V2 | | | | | |
| NS10-V2 | 10.4-inch TFT LED backlight | 640 × 480 dots | No | Ivory | NS10-TV00-V2 | UC1, CE, N, L, UL Type4 |
| | | | | Black | NS10-TV00B-V2 | |
| | | | Yes | Ivory | NS10-TV01-V2 | |
| Black | NS10-TV01B-V2 | | | | | |
| NS12-V2 | 12.1-inch TFT LED backlight | 800 × 600 dots | No | Ivory | NS12-TS00-V2 | |
| | | | | Black | NS12-TS00B-V2 | |
| | | | Yes | Ivory | NS12-TS01-V2 | |
| Black | NS12-TS01B-V2 | | | | | |
| NS15-V2 | 15-inch TFT | 1,024 × 768 dots | Yes | Silver | NS15-TX01S-V2 | |
| | | | | Black | NS15-TX01B-V2 | |
| NSH5-V2 Hand-held | 5.7-inch TFT | 320 × 240 dots | No | Black (Emergency stop button: Red) | NSH5-SQR10B-V2 | UC, CE |
| | | | | Black (Stop button: Gray) | NSH5-SQG10B-V2 | |

NS-Runtime

| Product name | Specifications | Media | Model | Standards |
|--------------|--|-------|------------|-----------|
| NS-Runtime | NS-Runtime Installer, PDF manual, hardware key (See note.) | CD | NS-NSRCL1 | — |
| | | | NS-NSRCL3 | |
| | | | NS-NSRCL10 | |

Note: A hardware key (USB dongle) is required for NS-Runtime operation.

●System Requirements

| Item | Specifications |
|-------------|---|
| OS | Windows XP (Service Pack 3 or higher), Vista, or 7 (Support 64-bit version only for Windows 7.) |
| CPU | Celeron, 1.3 GHz or higher (recommended) |
| Memory size | HDD: 50 MB min., RAM: 512 MB min. (Windows 7: 1 GB min.). 50 MB is required for the Runtime alone. (An additional 280 MB is required if CX-Server is not already installed.) |

Software

●How to select required support software for your controller

The required support software depends on the controller to connect. Please check the following table when purchasing the support software.

| Item | Omron PLC System | Omron Machine Automation Controller System |
|------------------------|-----------------------------------|--|
| Controller | CS, CJ, CP, and other series | NJ-series |
| Programmable Terminals | NS-series | NS-series with an Ethernet port |
| Software | FA Integrated Tool Package CX-One | Automation Software Sysmac Studio |

●FA Integrated Tool Package CX-One

| Product name | Specifications | | | Model | Standards |
|--|---|--------------------|-------|------------------------|-----------|
| | | Number of licenses | Media | | |
| FA Integrated Tool Package CX-One Ver.4. <input type="checkbox"/> | <p>The CX-One is a comprehensive software package that integrates Support Software for OMRON PLCs and components.</p> <p>CX-One runs on the following OS. Windows XP (Service Pack 3 or higher), Vista or 7 Note: Except for Windows XP 64-bit version</p> <p>CX-One Version 4.<input type="checkbox"/> includes CX-Designer Ver.3.<input type="checkbox"/>.</p> <p>For details, refer to the CX-One catalog (Cat. No. R134)</p> | license *1 | DVD | CX-ONE-AL01-EV4 | — |

*1. Multi licenses are available for the CX-One (3, 10, 30, or 50 licenses).

●Automation Software Sysmac Studio

Please purchase a DVD and required number of licenses the first time you purchase the Sysmac Studio. DVDs and licenses are available individually. Each model of licenses does not include any DVD.

| Product name | Specifications | | | Model | Standards |
|---|---|--------------------|-------|----------------------|-----------|
| | | Number of licenses | Media | | |
| Sysmac Studio Standard Edition Ver.1. <input type="checkbox"/> | <p>The Sysmac Studio provides an integrated development environment to set up, program, debug, and maintain NJ-series Controllers and other Machine Automation Controllers, as well as EtherCAT slaves.</p> <p>Sysmac Studio runs on the following OS. Windows XP (Service Pack 3 or higher, 32-bit version) /Vista (32-bit version) /7 (32-bit/64-bit version)</p> | - (Media only) | DVD | SYSMAC-SE200D | — |
| | <p>The Sysmac Studio Standard Edition DVD includes support software to set up EtherNet/IP Units, DeviceNet slaves, Serial Communications Units and support software for creating screens on HMIs (CX-Designer).</p> <p>For details, refer to the Sysmac Integrated Catalogue (P072).</p> | 1 license* | — | SYSMAC-SE201L | — |

Note: To connect the NJ-series Controller, NS system version 8.5 or higher is required. CX-Designer version 3.3 or higher is also required.

* Multi licenses are available for the Sysmac Studio (3, 10, 30, or 50 licenses).





Cable

| Product name | Specifications | | Model | Standards |
|--|--|---------------|-----------------------|-----------|
| Cable *1  | Screen transfer cable for DOS/V (CX-Designer ↔ PT) | Length: 2 m | XW2Z-S002 | — |
| | USB-Serial Conversion cable | Length: 0.5 m | CS1W-CIF31 | N |
| | USB relay cable | Length: 1 m | NS-USBEXT-1M | — |
| NSH5 Cables | RS-422A cable (loose wires + D-Sub 9-pin) | Length: 10 m | NSH5-422CW-10M | — |
| | RS-232C cable (loose wires + D-Sub 9-pin) | Length: 3 m | NSH5-232CW-3M | |
| | RS-232C cable (loose wires + D-Sub 9-pin) | Length: 10 m | NSH5-232CW-10M | |
| UL-compliant NSH5 Cable | RS-422A cable (loose wires) | Length: 10 m | NSH5-422UL-10M | CU |
| | RS-232C cable (loose wires + relay cable) | Length: 3 m | NSH5-232UL-3M | |
| | RS-232C cable (loose wires + relay cable) | Length: 10 m | NSH5-232UL-10M | |
| PT-to-PLC Connecting Cable *2 | PT connection: 9 pins PLC connection: 9 pins | Length: 2 m | XW2Z-200T | — |
| | | Length: 5 m | XW2Z-500T | |
| | PT connection: 9 pins PLC peripheral port | Length: 2 m | XW2Z-200T-2 | |
| | | Length: 5 m | XW2Z-500T-2 | |
| NSH5 Removable Box Cable | RS-232C cable (connectors) | Length: 3 m | NSH5-232CN-3M | — |
| | | Length: 10 m | NSH5-232CN-10M | |
| NSH5 Removable Box | — | | NSH5-AL001 | |
| NSH5 Wall-mounting Bracket | — | | NSH5-ATT02 | |
| NSH5 Visor | — | | NSH5-ATT01 | |

*1. Use a standard USB Type A male to Type B type male cable to connect the NS series PT to a personal computer (CX-Designer).
Use a standard USB cable to connect the NS series PT to a PictBridge-compatible printer. USB cable type depends on the printer.

*2. To connect the NS series PT to NJ series controller, using a commercially available 10/100-BASE-TX twisted-pair cable.
For detail, refer to the NS series SETUP MANUAL (Cat. No.V083).

Options

| Product name | Specifications | Model | Standards | |
|--|---|----------------|---------------|---|
| Video Input Unit  | Inputs: 4 channels Signal type: NTSC/PAL | NS-CA001 | UC1, CE | |
| | Input channels: 2 video channels and 1 RGB channel *1 Signal type: NTSC/PAL | NS-CA002 | | |
| Special Cable for the Console | Cable length: 2 m | F150-VKP (2 m) | — | |
| | Cable length: 5 m | F150-VKP (5 m) | | |
| Controller Link Interface Unit  | For Controller Link Communications | NS-CLK21 | UC1, CE | |
| RS-422A Adapter  | Transmission distance: 500 m total length Note: Use this model when connecting PT models without a V□ suffix. Note: PT models with the V□ suffix can also be connected. | NS-AL002 | — | |
| | Transmission distance: 50 m total length Note: Only PT models with a suffix of V□ are connectable. Use the NS-AL002 to connect models without a V□ suffix. | CJ1W-CIF11 | UC1, N, L, CE | |
| Sheet/Cover *2  | Anti-reflection sheets (5 surface sheets) | NS15 | NS15-KBA04 | — |
| | | NS12/10 | NS12-KBA04 | |
| | | NS8 | NS7-KBA04 | |
| | | NS5 | NT30-KBA04 | |
| | Protective covers (5 pack) (anti-reflection coating) | NS12/10 | NS12-KBA05 | |
| | | NS8 | NS7-KBA05 | |
| | | NS5 | NT31C-KBA05 | |
| | Protective covers (1 cover included) (Transparent) | NS15 | NS15-KBA05N | |
| | Protective covers (5 covers included) (Transparent) | NS12/10 | NS12-KBA05N | |
| | | NS8 | NS7-KBA05N | |
| NS5 | | NT31C-KBA05N | | |
| Attachment | NT625C/631/631C Series to NS12/10 Series | NS12-ATT01 | | |
| | NT625C/631/631C Series to NS12/NS10 Series (Black) | NS12-ATT01B | | |
| | NT610C Series to NS12/10 Series | NS12-ATT02 | | |
| | NT620S/620C/600S Series to NS8 Series | NS8-ATT01 | | |
| | NT600M/600G/610G/612G Series to NS8 Series | NS8-ATT02 | | |
| Memory Card  | 128 MB | HMC-EF183 | | |
| | 256 MB | HMC-EF283 | | |
| | 512 MB | HMC-EF583 | | |
| Memory Card Adapter | --- | HMC-AP001 | CE | |
| Replacement Battery | Battery life: 5 years (at 25°C) | CJ1W-BAT01 | — | |
| Bar Code Reader | CCD handheld bar code reader (RS-232C interface) | V520-RH21-6 | | |

*1. One screen cannot display two video inputs simultaneously.

*2. A Chemical-resistant Cover (NT30-KBA01) is available only for the NS5.

General Specifications

NS5/NS8/NS10/NS12/NS15

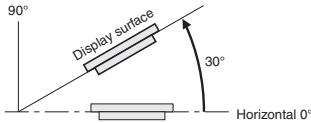
| Series | NS5-V2 | NS8-V2 | NS10-V2 | NS12-V2 | NS15-V2 |
|---|--|-------------|-------------|-------------|---|
| Rated power supply voltage | 24 VDC | | | | |
| Allowable voltage range | 20.4 to 27.6 VDC (24 VDC \pm 15%) | | | | |
| Power consumption | 15 W max. | 25 W max. | | | 45 W max. |
| Ambient operating temperature | 0 to 50 °C (See note on the next page.) Note: The ambient operating temperature is subject to the following restrictions according to the mounting angle. Mounting angle of 0 to 30° to the horizontal: <ul style="list-style-type: none"> • When no Expansion Units are mounted, the operating temperature range is 0 to 45°C. • When a Video Input Unit or a Controller Link Interface Unit is mounted, the ambient operating temperature is 0 to 35°C. Mounting angle of 30 to 90° to the horizontal: Operating temperature range of 0 to 50°C | | | |  |
| Storage temperature | -20 to 60 °C *1 | | | | |
| Ambient operating humidity | 35 to 85% (0 to 40 °C), 35 to 60% (40 to 50 °C) (with no condensation) | | | | |
| Operating environment | No corrosive gases. | | | | |
| Noise immunity | Conforms to IEC61000-4-4, 2 kV (power lines). | | | | |
| Vibration resistance (during operation) | 10 to 57 Hz, 0.075 mm amplitude, 57 to 150 Hz, 9.8 m/s ² 30 min each in X, Y, and Z directions | | | | 5 to 8.4 Hz, 3.5 mm single amplitude, 8.4 to 150 Hz, 9.8 m/s ² 10 min times each in X, Y, and Z directions |
| Shock resistance (during operation) | 147 m/s ² 3 times each in direction of X, Y, and Z | | | | |
| Weight | 1.0 kg max. | 2.0 kg max. | 2.3 kg max. | 2.5 kg max. | 4.2 kg max. |
| Degree of protection | Front operating panel: Equivalent to IP65 oil-proof type and NEMA4 UL type 4. *2 Note: May not be applicable in locations with long-term exposure to oil. | | | | |
| Ground | Ground to 100 Ω or less. | | | | |
| Battery life | 5 years (at 25 °C): Replace battery within 5 days after the battery runs low (indicator lights orange). | | | | |
| Applicable standards | Certified for conformance to UL 508, UL 1604, EMC Directive, NK, and LR Standards. | | | | |

*1. Operate the PT within the temperature and humidity ranges shown in the right diagram.

*2. Support for NS5, NS10, NS12 and NS15.

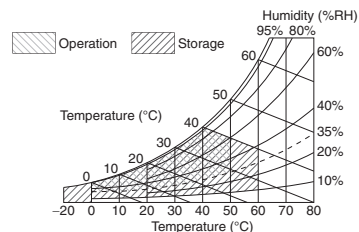

NSH5 Hand-held PT

| Series | NSH5-V2 | |
|---|--|------------------------------------|
| Type | 5.7-inch Color TFT (Hand-held Version) | |
| Case colour | black | |
| Built-in Ethernet port | No | |
| Model | NSH5-SQR10B-V2 (Emergency stop button: Red) | NSH5-SQG10B-V2 (Stop button: Gray) |
| Rated power supply voltage | 24 VDC | |
| Allowable voltage range | 20.4 to 27.6 VDC (24 VDC \pm 15%) | |
| Power consumption | 10 W max. | |
| Ambient operating temperature | 0 to 40°C | |
| Storage temperature | -20 to 60°C | |
| Ambient operating humidity | 35% to 85% (0 to 40°C) with no condensation | |
| Operating environment | No corrosive gases. | |
| Noise immunity | Common mode: 1,000 Vp-p (between power supply terminals and panel) Normal mode: 300 Vp-p Pulse width: 100 ns to 1 μ s, Rise time: 1-ns pulse | |
| Vibration resistance (during operation) | 10 to 57 Hz, 0.075 mm amplitude, 57 to 150 Hz, 9.8 m/s ² 30 min each in X, Y, and Z directions | |
| Shock resistance (during operation) | 147 m/s ² 3 times each in direction of X, Y, and Z | |
| Weight | 1 kg max. | |
| Degree of protection | Equivalent to IP65. | |
| Ground | Ground to 100 Ω or less. | |
| Battery life | 5 years (at 25°C): Replace battery within 5 days after the battery runs low (indicator lights orange). | |
| Applicable standards | Certified for conformance to UL 508, EMC Directive, and EN 60204-1. | |

Austria

Tel: +43 (0) 2236 377 800
www.industrial.omron.at

Belgium

Tel: +32 (0) 2 466 24 80
www.industrial.omron.be

Czech Republic

Tel: +420 234 602 602
www.industrial.omron.cz

Denmark

Tel: +45 43 44 00 11
www.industrial.omron.dk

Finland

Tel: +358 (0) 207 464 200
www.industrial.omron.fi

France

Tel: +33 (0) 1 56 63 70 00
www.industrial.omron.fr

Germany

Tel: +49 (0) 2173 680 00
www.industrial.omron.de

Hungary

Tel: +36 1 399 30 50
www.industrial.omron.hu

Italy

Tel: +39 02 326 81
www.industrial.omron.it

Netherlands

Tel: +31 (0) 23 568 11 00
www.industrial.omron.nl

Norway

Tel: +47 (0) 22 65 75 00
www.industrial.omron.no

Poland

Tel: +48 22 458 66 66
www.industrial.omron.pl

Portugal

Tel: +351 21 942 94 00
www.industrial.omron.pt

Russia

Tel: +7 495 648 94 50
www.industrial.omron.ru

South Africa

Tel: +27 (0)11 579 2600
www.industrial.omron.co.za

Spain

Tel: +34 913 777 900
www.industrial.omron.es

Sweden

Tel: +46 (0) 8 632 35 00
www.industrial.omron.se

Switzerland

Tel: +41 (0) 41 748 13 13
www.industrial.omron.ch

Turkey

Tel: +90 212 467 30 00
www.industrial.omron.com.tr

United Kingdom

Tel: +44 (0) 870 752 08 61
www.industrial.omron.co.uk

More Omron representatives

www.industrial.omron.eu

Automation Systems

- Programmable logic controllers (PLC) • Human machine interfaces (HMI) • Remote I/O
- Industrial PC's • Software

Motion & Drives

- Motion controllers • Servo systems • Inverters • Robots

Control Components

- Temperature controllers • Power supplies • Timers • Counters • Programmable relays
- Digital panel indicators • Electromechanical relays • Monitoring products • Solid-state relays
- Limit switches • Pushbutton switches • Low voltage switch gear

Sensing & Safety

- Photoelectric sensors • Inductive sensors • Capacitive & pressure sensors
- Cable connectors • Displacement & width-measuring sensors • Vision systems
- Safety networks • Safety sensors • Safety units/relay units • Safety door/guard lock switches